



LCD TV

OWNER'S MANUAL

MODEL: 23LX1RV



Internet Home Page : <http://www.lge.com>
<http://www.lg.ca>



Please read this manual carefully before operating your set.
Retain it for future reference.
Record model number and serial number of the set.
See the label attached on the back cover and quote
this information to your dealer
when you require service.

Warning



CAUTION
RISK OF ELECTRIC SHOCK
DO NOT OPEN



WARNING:

TO REDUCE THE RISK OF ELECTRIC SHOCK DO NOT REMOVE COVER (OR BACK). NO USER SERVICEABLE PARTS INSIDE. REFER TO QUALIFIED SERVICE PERSONNEL.



The lightning flash with arrowhead symbol, within an equilateral triangle, is intended to alert the user to the presence of uninsulated "dangerous voltage" within the product's enclosure that may be of sufficient magnitude to constitute a risk of electric shock to persons.



The exclamation point within an equilateral triangle is intended to alert the user to the presence of important operating and maintenance (servicing) instructions in the literature accompanying the appliance.

NOTE TO CABLE/TV INSTALLER:

This reminder is provided to call the CATV system installer's attention to Article 820-40 of the National Electric Code (U.S.A.). The code provides guidelines for proper grounding and, in particular, specifies that the cable ground shall be connected to the grounding system of the building, as close to the point of the cable entry as practical.

REGULATORY INFORMATION

This equipment has been tested and found to comply with the limits for a Class B digital device, pursuant to Part 15 of the FCC Rules. These limits are designed to provide reasonable protection against harmful interference in a residential installation. This equipment generates, uses and can radiate radio frequency energy and, if not installed and used in accordance with the instructions, may cause harmful interference to radio communications. However, there is no guarantee that interference will not occur in a particular installation. If this equipment does cause harmful interference to radio or television reception, which can be determined by turning the equipment off and on, the user is encouraged to try to correct the interference by one or more of the following measures:

- Reorient or relocate the receiving antenna.
- Increase the separation between the equipment and receiver.
- Connect the equipment into an outlet on a circuit different from that to which the receiver is connected.
- Consult the dealer or an experienced radio/TV technician for help.

Any changes or modifications not expressly approved by the party responsible for compliance could void the user's authority to operate the equipment.

CAUTION:

Do not attempt to modify this product in any way without written authorization from LG Electronics Corporation. Unauthorized modification could void the user's authority to operate this product.

U.S.A. only -----

COMPLIANCE:

The responsible party for this product's compliance is:
LG Electronics U.S.A., Inc.
1000 Sylvan Avenue, Englewood Cliffs, NJ 07632
Phone: 1-201-816-2000
<http://www.lgusa.com>

Safety Instructions

WARNING :

To Reduce The Risk Of Fire Or Electric Shock, Do Not Expose This Apparatus To Rain Or Moisture.

Apparatus shall not be exposed to dripping or splashing and no objects filled with liquids, such as vases, shall be placed on the apparatus.

IMPORTANT SAFETY INSTRUCTIONS

1. Read these instructions.

2. Keep these instructions.

3. Heed all warnings.

4. Follow all instructions.



5. Do not use this apparatus near water.



6. Clean only with a dry cloth.



7. Do not block any of the ventilation openings. Install in accordance with the manufacturer's instructions.



8. Do not install near any heat sources such as radiators, heat registers, stoves, or other apparatus (including amplifiers) that produce heat.



9. Do not defeat the safety purpose of the polarized or grounding type plug. A polarized plug has two blades with one wider than the other. A grounding type plug has two blades and a third grounding prong. The wide blade or the third prong is provided for your safety. When the provided plug does not fit into your outlet, consult an electrician for replacement of the obsolete outlet.

10. Protect the power cord from being walked on or pinched particularly at plugs, convenience receptacles, and the point where they exit from the apparatus.



11. Only use the attachments / accessories specified by the manufacturer.

12. Use only with a cart, stand, tripod, bracket, or table specified by the manufacturer, or sold with the apparatus. When a cart is used, use caution when moving the cart / apparatus combination to avoid injury from tip-over.



14. Refer all servicing to qualified service personnel. Servicing is required when the apparatus has been damaged in any way, such as power supply cord or plug is damaged, liquid has been spilled or objects have fallen into the apparatus, the apparatus has been exposed to rain or moisture, does not operate normally, or has been dropped.

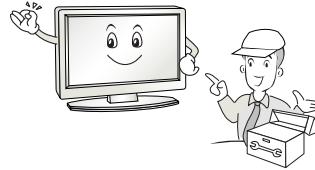

13. Unplug this apparatus during lightning storms or when unused for long periods of time.



Note

- If the TV feels cold to the touch, there may be a small “flicker” when when it is turned on. This is normal, there is nothing wrong with TV.
- Some minute dot defects may be visible on the screen, appearing as tiny red, green, or blue spots. However, they have no adverse effect on the monitor's performance.
- Avoid touching the LCD screen or holding your finger(s) against it for long periods of time. Doing so may produce some temporary distortion effects on the screen.

CAUTION concerning the Power Cord

Most appliances recommend they be placed upon a dedicated circuit; that is, a single outlet circuit which powers only that appliance and has no additional outlets or branch circuits. Check the specification page of this owner's manual to be certain.

Do not overload wall outlets. Overloaded wall outlets, loose or damaged wall outlets, extension cords, frayed power cords, or damaged or cracked wire insulation are dangerous. Any of these conditions could result in electric shock or fire. Periodically examine the cord of your appliance, and if its appearance indicates damage or deterioration, unplug it, discontinue use of the appliance, and have the cord replaced with an exact replacement part by an authorized servicer.

Protect the power cord from physical or mechanical abuse, such as being twisted, kinked, pinched, closed in a door, or walked upon. Pay particular attention to plugs, wall outlets, and the point where the cord exits the appliance.

On Disposal

- a. The fluorescent lamp used in this product contains a small amount of mercury.
- b. Do not dispose of this product with general household waste.
Disposal of this product must be carried out in accordance to the regulations of your local authority.

Accessories

Ensure that the following accessories are included with your TV. If any accessory is missing, please contact the dealer from where you purchased the product.

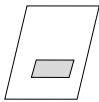

Owner's Manual



Power Cord

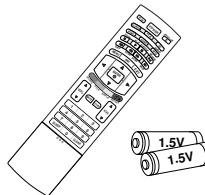

Remote Control / Batteries



Polishing cloth

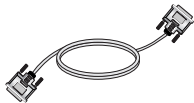

DVI-D cable (PC)

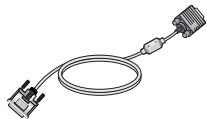

DVI to D-Sub cable (PC)



Audio cable (PC)



Twister Holder

Contents

Introduction

- 5 Accessories
- 8 **Controls**
- 9 **Connection Options**
- 10 **Remote Control**

Installation

- 13 **Basic Connection**
- 14 **External Equipment Connections**
- 14 Antenna Connection
- 15 VCR Setup
- 16 External AV Source Setup
- 17 External DVD Setup
- 18 DVD Output Setup
- 19 DTV Setup
- 20 PC Setup
- 20 Power Cord Connection

Operation

- Basic operation
-
- Setting up TV stations
-
- Picture adjustment
-
- Sound adjustment
-
- Timer menu
-
- Setup menu

TV

- 21 Turning On/Off the TV
- 21 Volume Adjustment
- 21 Programme selection
- 21 On screen language selection
- 22 How to adjust the OSD screen
-
- 23 Memorizing the Channels with EZ scan
- 24 Add/Delete Channels with Manual program
-
- 24 Favorite Channels Setup
- 25 EZ Video
- 25 Manual Picture Control (User option)
- 26 Cinema Mode Setup
- 26 Picture format (ARC-Aspect Ratio Correction)
-
- 27 EZ Audio
- 27 Equalizer Adjustments
- 28 AVL (Auto Volume Leveler)
- 28 Sound Balance
- 29 Stereo/SAP Broadcasts Setup
-
- 30 Auto Clock Setup
- 30 Manual Clock Setup
- 31 On/Off Timer Setup
- 31 Sleep timer Setup
- 32 Auto off
-
- 33 **Closed Captions**
- 34 Caption/Text
- 34 Captions
- 35 Key Lock
- 35 Lightening Logo Display Lamp
- 36 **Parental Menu Options**

Contents

Operation

PC menu options

DVD Menu options

DVD Operation

Reference

- 37 Auto Configure
- 37 H-Position / V-Position
- 38 Clock / Phase
- 38 Reset

DVD

39 Notes on Discs

41 Language

- 41 Menu Language
- 41 Disc Audio / Disc Subtitle / Disc Menu

42 Display

- 42 Progressive Scan

43 Audio

- 43 Dolby Digital / DTS / MPEG
- 43 Sample Freq. (Frequency)
- 44 DRC (Dynamic Range Control)
- 44 Vocal

45 Lock

- 45 Rating
- 46 Password (Security Code)
- 46 Area Code

47 OTHERS

- 47 PBC
- 47 AUTO PLAY
- 48 B.L.E (Black Level Extension)
- 49 DivX(R) VOD

50 Playing a DVD or Video CD

- 50 Basic Playback / Stop Playback / Pause Playback (Still mode)
- 50 Still Picture and Frame-by-Frame Playback / Fast Forward/Backward
- 51 Slow Motion
- 51 Moving to another CHAPTER/TRACK
- 51 Repeat Playback
- 52 Disc Menu / Title Menu
- 53 On-Screen Display
- 54 A-B Repeat Playback / Random Playback / Camera Angle
- 55 Subtitles / Marker Search / Zoom

56 Playing an Audio CD or MP3/WMA Disc

- 56 Pause Playback (Still mode)
- 56 Fast Forward/Backward
- 56 Moving to another Track
- 57 Repeat Playback / A-B Repeat Playback / Random Playback / 3D Surround

58 Programmed Playback

59 Viewing a JPEG Disc

40 Viewing a DVD VR format Disc

61 Playing a DivX Movie Disc

62 Language Codes

62 Area Codes

Introduction

Controls

- This is a simplified representation of front panel.
- Here shown may be somewhat different from your TV.

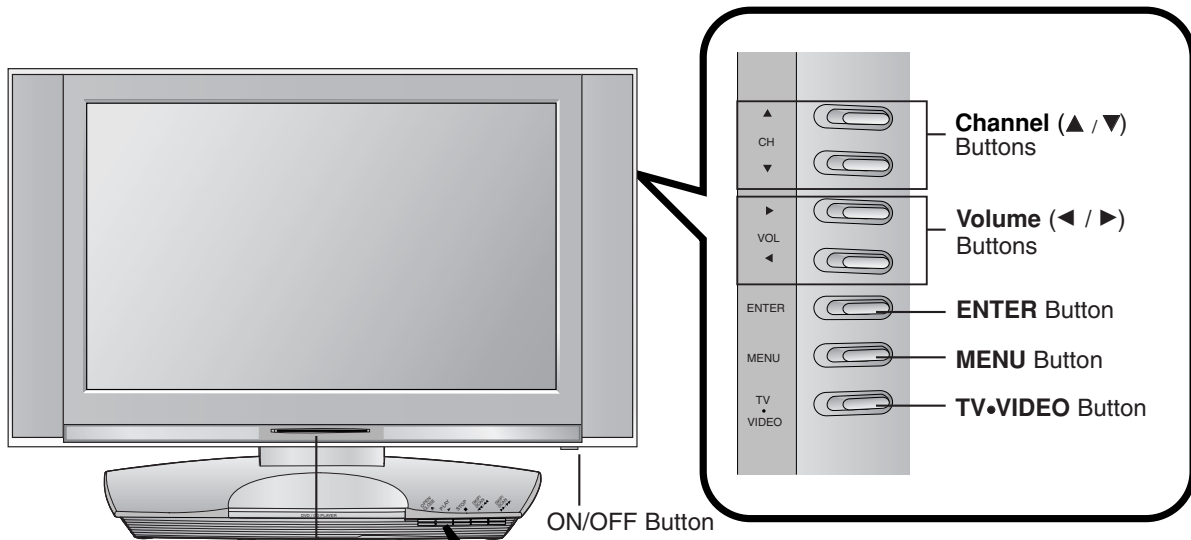

Remote Control Sensor
Power/Standby Indicator
Illuminates red in standby mode, illuminates green when the set is switched on.

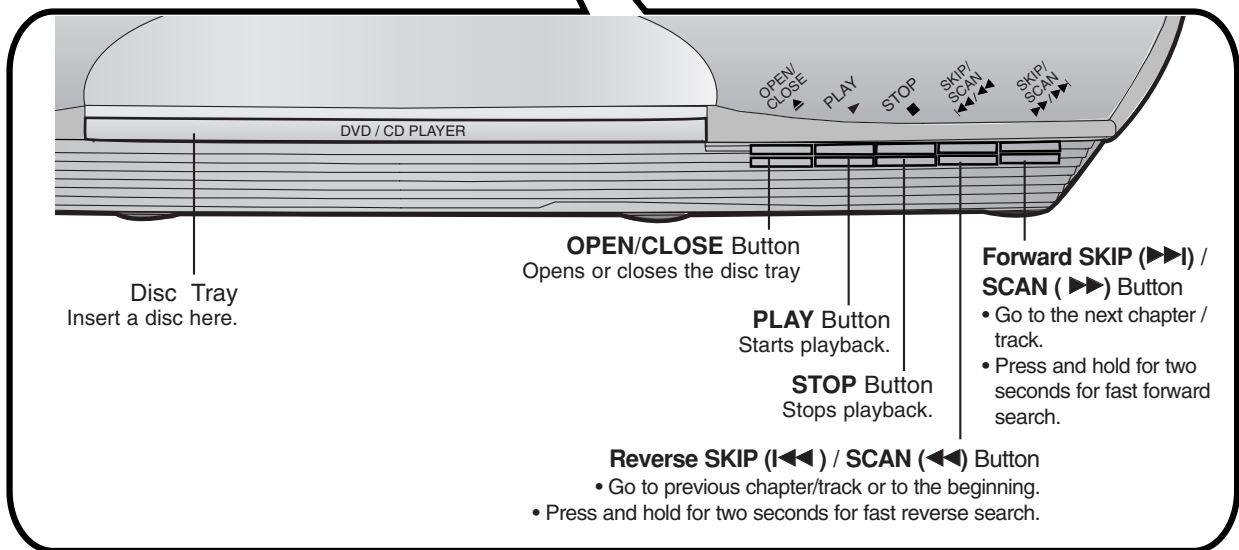

Introduction

Connection Options

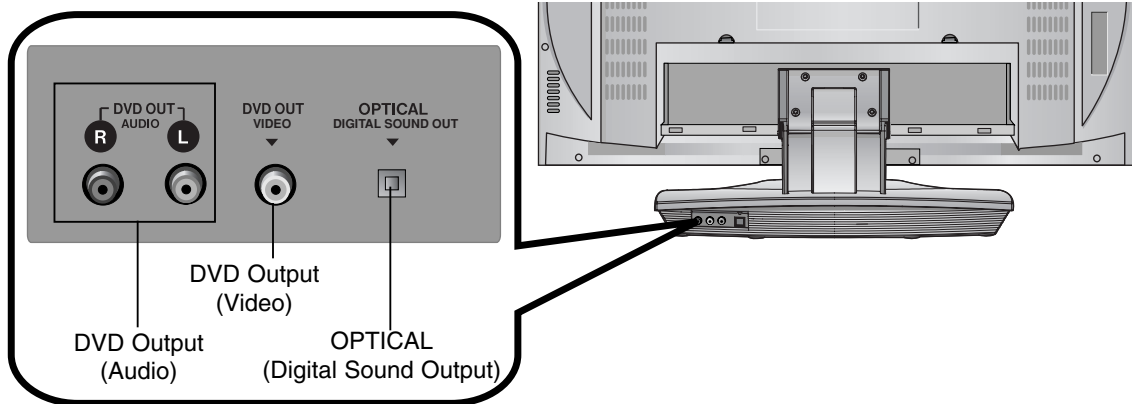
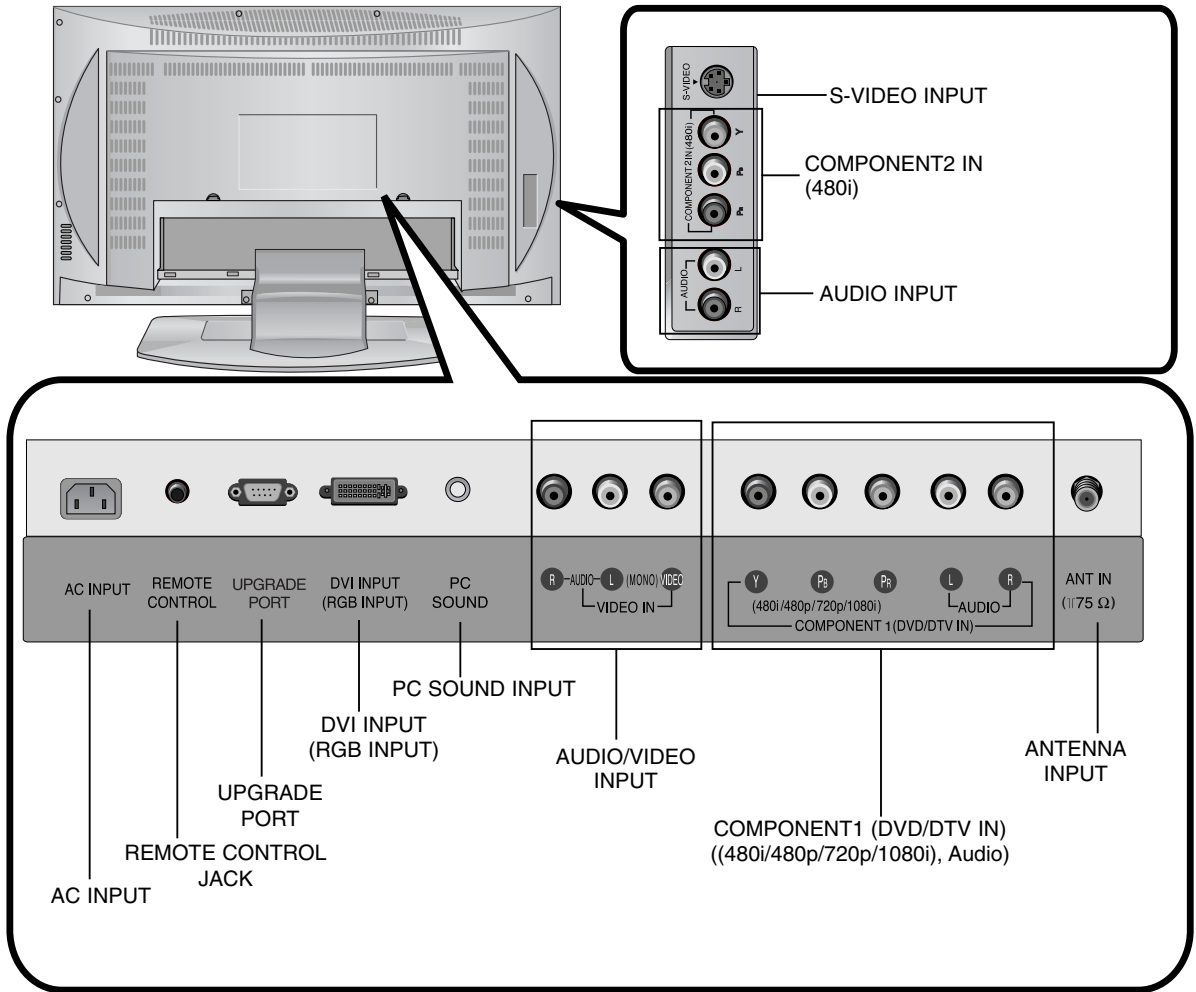

Remote Control

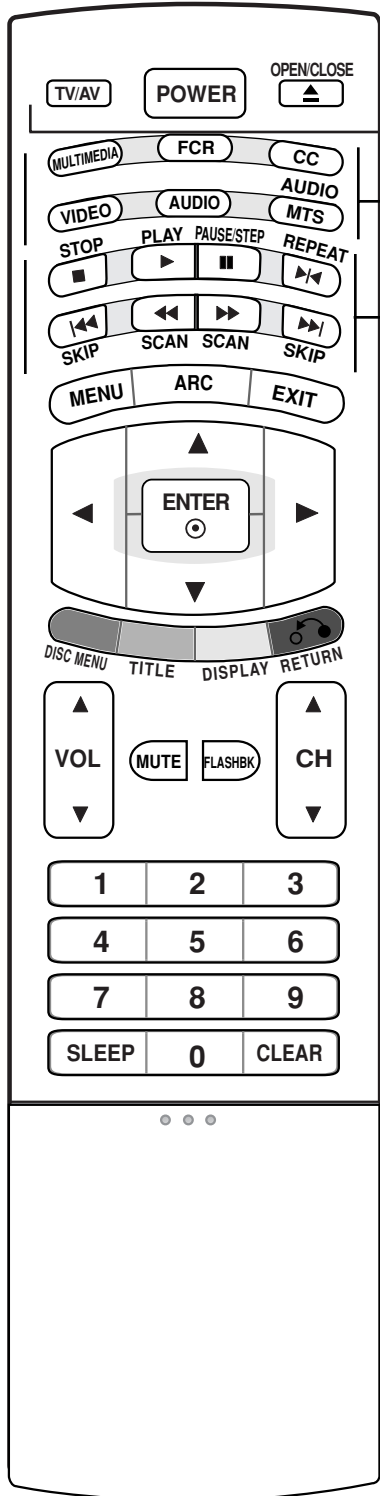

POWER

Switches the set **On** from standby or **Off** to standby.

TV/AV

- Selects: **TV, Video, S-Video, DVD, Component 1, Component 2,** or **PC** mode.
- Clears the menu from the screen.
- Switches the set **On** from standby.

OPEN/CLOSE

Opens or closes the disc tray.

MULTIMEDIA

- Selects: **TV, DVD, Component 1, Component 2** or **PC** mode.
- Clears the menu from the screen.
- Switches the set **On** from standby.

FCR

The selected favorite channel will be displayed sequentially. (Refer to p.24)

CC

Select a closed caption: **Off, EZ Mute** or **On**. (Refer to p.34)

Video

Recalls your preferred picture setting. (Refer to p.25)

Audio

Recalls your preferred sound setting. (Refer to p.27)

MTS

- Press to step through audio signal settings (Mono, MTS Stereo and SAP). (Refer to p.29)

DVD buttons

■ STOP

Stops playback.

▶ PLAY

Starts playback.

⏸ PAUSE / STEP

Pauses playback temporarily.

◀◀ SCAN / ▶▶ SCAN

Search backward or forward.

⏮ SKIP

Returns to beginning of current chapter/track or go to previous chapter/track.

⏭ SKIP

Go to next chapter or track.

▶◀ (REPEAT)

For further details, see the '**DVD operation: Playing a DVD or Video CD**' section. (Refer to p.50)

Introduction

Remote Control

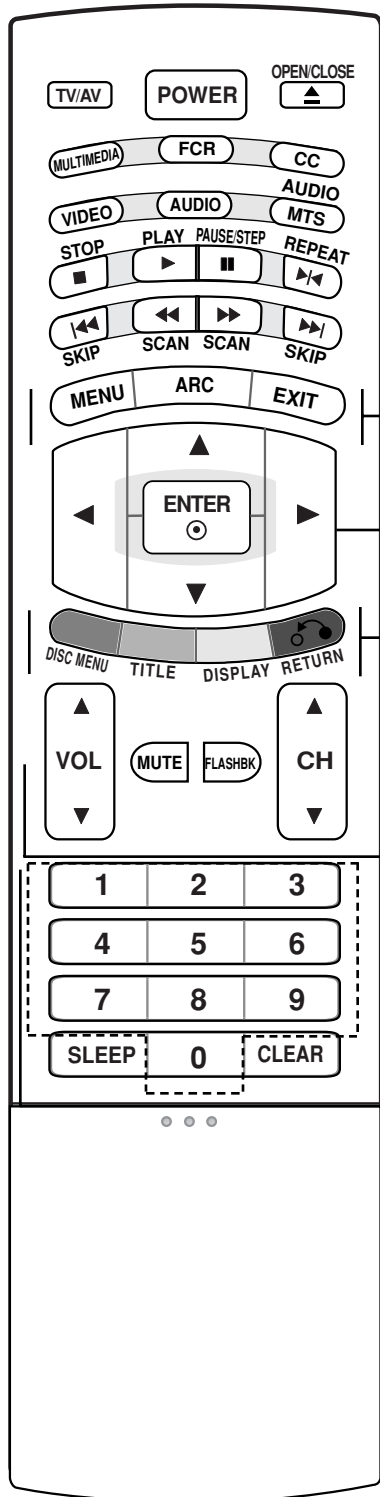

MENU
Selects a menu.

ARC
Selects your desired picture format. (Refer to p.26)

EXIT
Exits from each mode.

▲ / ▼ / ◀ / ▶ (up / down / left / right)
Selects or adjusts an item in the menu.

ENTER
Accepts your selection or displays the current mode.

DISC MENU
Accesses menu on a DVD disc. (Refer to p.52)

TITLE
Displays title menu, if available. (Refer to p.52)

DISPLAY
Accesses On-Screen display during DVD playback. (Refer to p.53)

RETURN

- Returns to playback.
- Hides information of file while viewing a JPEG file. (Refer to p.59)

VOL (Volume) ▲ / ▼
Adjusts the volume.

MUTE
Switches the sound **On** or **Off**.

FLASHBK

- Returns to the previously viewed programme.

CH (Channel) ▲ / ▼
Selects a programme.

0-9 number buttons

- Selects a programme.
- Selects numbered items in a menu.

SLEEP
Sets the sleep timer. (Refer to p.31)

CLEAR
Removes a track number on the **program** list or a mark on the **MARKER SEARCH** menu. (Refer to p.55)

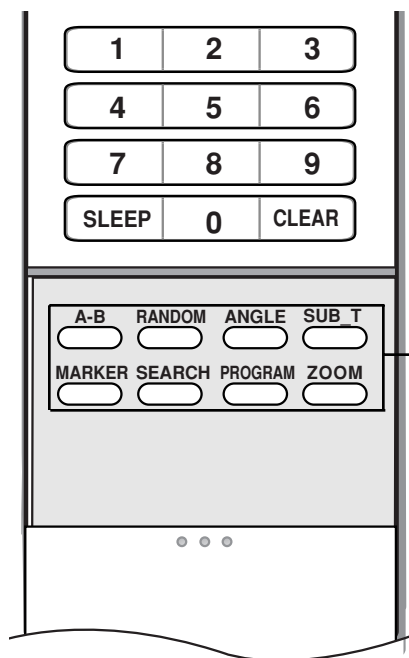

A-B

Repeat sequence. (Refer to p.54)

RANDOM

Plays chapters or tracks in random order. (Refer to p.54)

ANGLE

Selects a DVD camera angle if available. (Refer to p.54)

SUB T (SUBTITLE)

Selects a subtitle language. (Refer to p.55)

MARKER

Marks any point during playback. (Refer to p.55)

SEARCH

Displays MARKER SEARCH menu. (Refer to p.55)

PROGRAM

Places a track on the program list. (Refer to p.58)

ZOOM

Changes the picture size during DVD playback. (Refer to p.55)

Installing Batteries

- 1** Open the battery compartment cover on the back side.

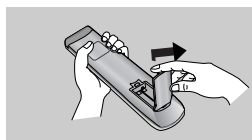

- 2** Insert two 1.5V AA size batteries in correct polarity (+ with +, - with -). Don't mix old or used batteries with new ones.

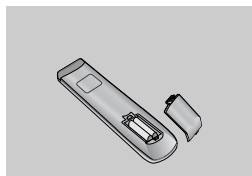

- 3** Close the cover.

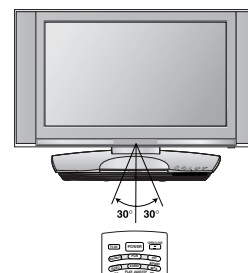
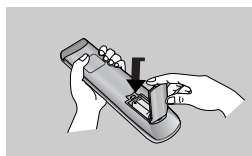

* Use a remote control 7 meter distance and 30 degree (left/right) within the receiving unit scope.

* Dispose of used batteries in the recycle bin to prevent environment.

Installation

Basic Connection

- 1 Pull the back cover backside while pushing the two tabs and then lift it up.

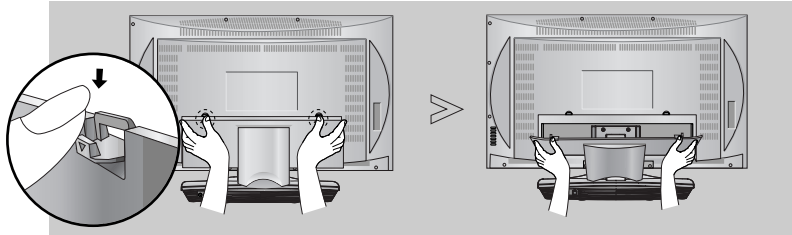

- 2 Connect the cables as necessary.
To connect an additional equipment, see the **External equipment Connections** section.

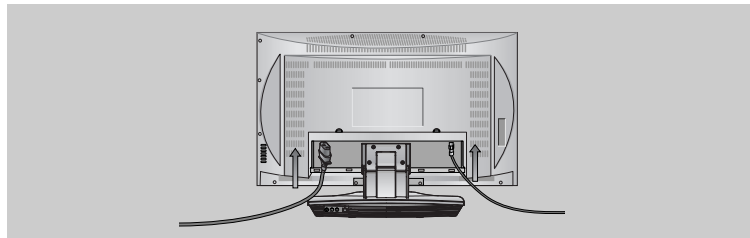

- 3 Align the holes on the TV back panel with the protuberances on the back cover and insert.

- Cable Arrangement

Pull the cables through the hole on the set and bundle the cables using the supplied twister holder.

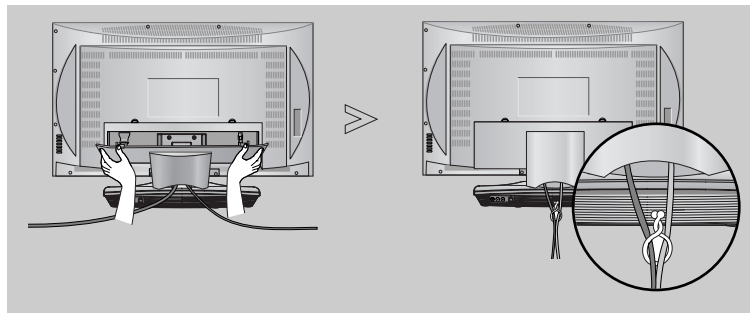

Desktop Pedestal Installation

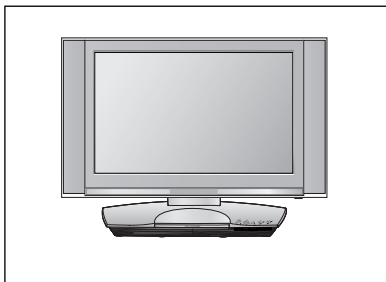

For proper ventilation, allow a clearance of 4" on each side and from the wall.

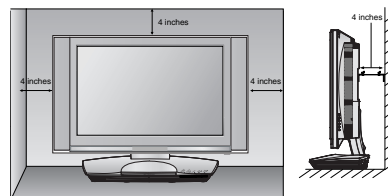

External Equipment Connections

To prevent the equipment damage, never plug in any power cords until you have finished connecting all equipment.

Antenna Connection

- Antenna or Cable Service without a Cable Box Connection.
- For optimum picture quality, adjust antenna direction if needed.

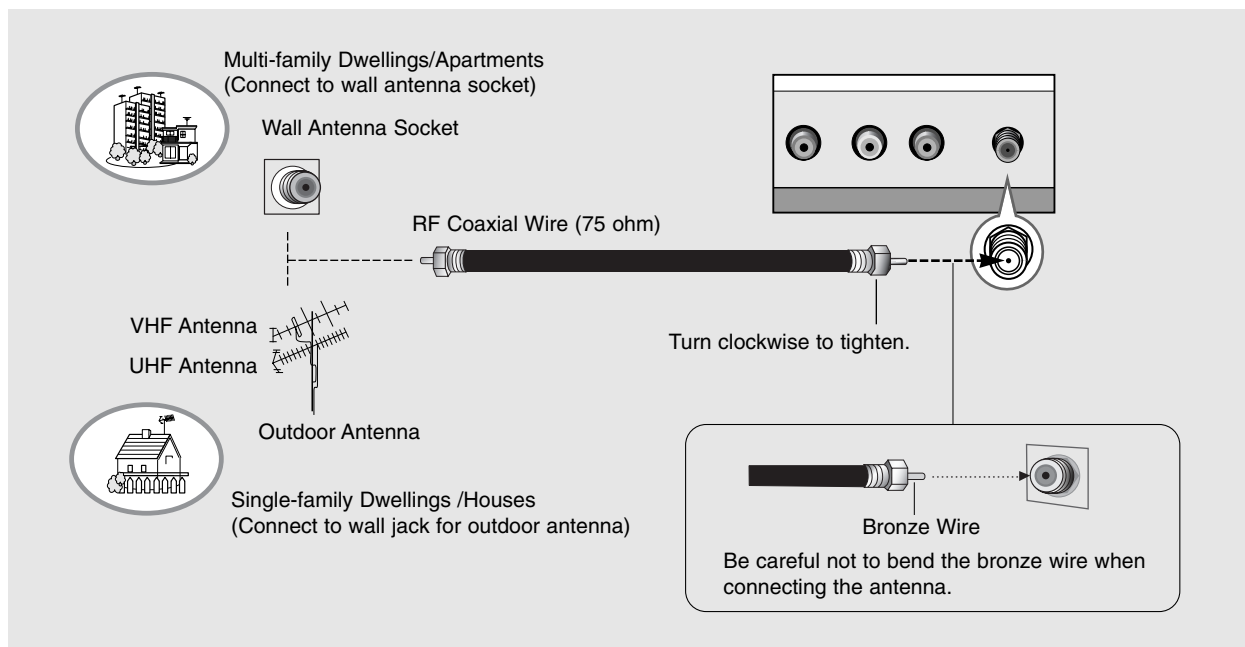

- In a poor signal area to improve picture quality, purchase and install a signal amplifier.
- If the antenna needs to be split for two TV's, install a "2-Way Signal Splitter" in the connections.
- If the antenna is not installed properly, contact your dealer for assistance.

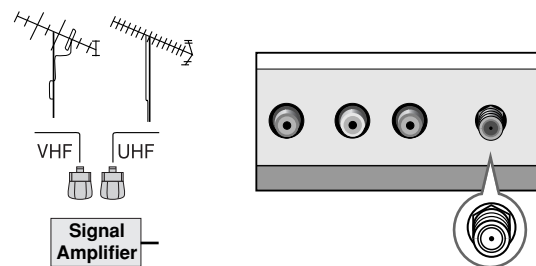

Installation

External Equipment Connections

VCR Setup

- To avoid picture noise (interference), leave an adequate distance between the VCR and TV.
- Typically a frozen still picture from a VCR. If the 4:3 picture format is used; the fixed images on the sides of the screen may remain visible on the screen.

When connecting with an antenna cable

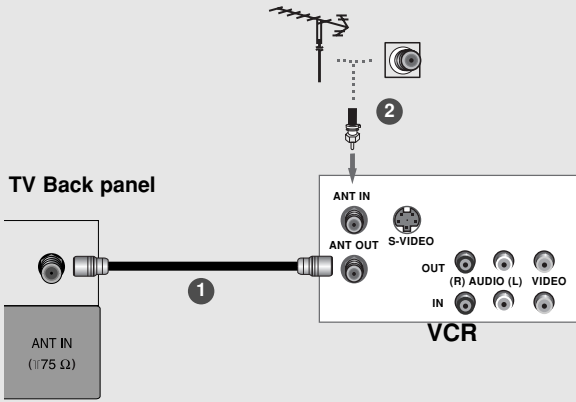

- 1 Connect the RF antenna out socket of the VCR to the **Antenna** socket on the set.
- 2 Connect the antenna cable to the RF antenna in socket of the VCR.
- 3 Set VCR output switch to 3 or 4 and then tune TV to the same channel number.
- 4 Insert a video tape into the VCR and press **PLAY** on the VCR. (Refer to the VCR owner's manual.)

When connecting with a RCA cable

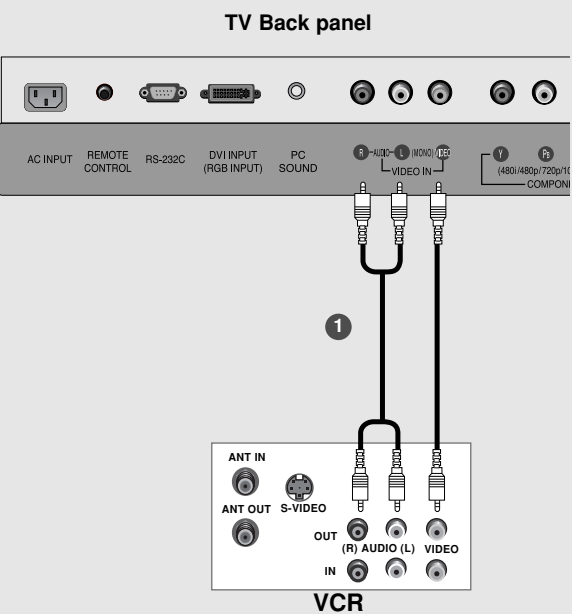

- 1 Connect the **AUDIO/VIDEO** jacks between TV and VCR. Match the jack colors (Video = yellow, Audio Left = white, and Audio Right = red)
- 2 Insert a video tape into the VCR and press **PLAY** on the VCR. (Refer to the VCR owner's manual.)
- 3 Select **Video** input source with using the **TV/AV** button on the remote control.

 • If you have a mono VCR, connect the audio cable from the VCR to the **AUDIO L/MONO** jack of the set.

When connecting with an S-Video cable

TV side panel

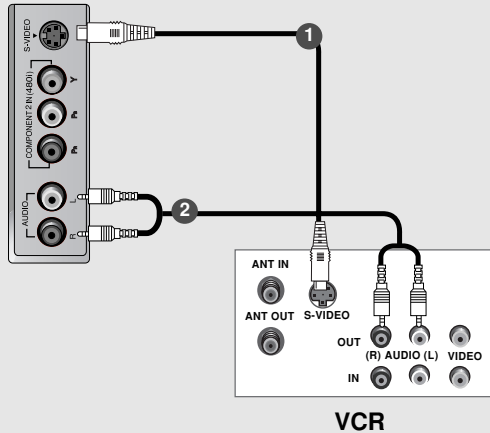

- 1 Connect the an S-VIDEO output of the VCR to the S-VIDEO input on the set. The picture quality is improved; compared to connecting a regular VCR to the Video input.
- 2 Connect the audio outputs of the VCR to the **AUDIO** input jacks on the set.
- 3 Insert a video tape into the VCR and press **PLAY** on the VCR. (Refer to the VCR owner's manual.)
- 4 Select **S-Video** input source with using the **TV/AV** button on the remote control.



Do not connect to both Video and S-Video at the same time.

External AV Source Setup

TV side panel

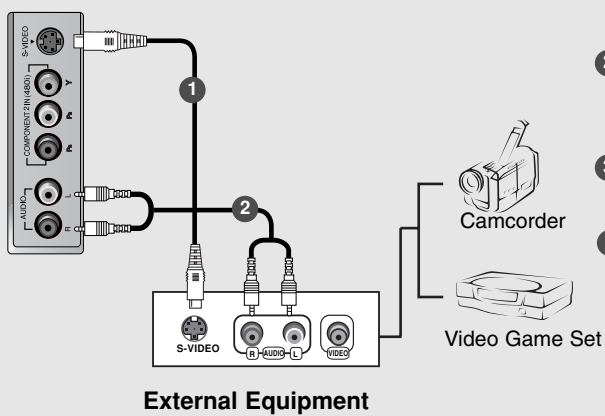

- 1 Connect the **S-VIDEO** output of the external equipment to the **S-VIDEO** input on the set.
- 2 Connect the **AUDIO** jacks between TV and external equipment. Match the jack colors (Video = yellow, Audio Left = white, and Audio Right = red).
- 3 Select **S-Video** input source with using the **TV/AV** button on the remote control.
- 4 Operate the corresponding external equipment. Refer to external equipment operating guide.

Installation

External Equipment Connections

External DVD Setup

When connecting with a component cable

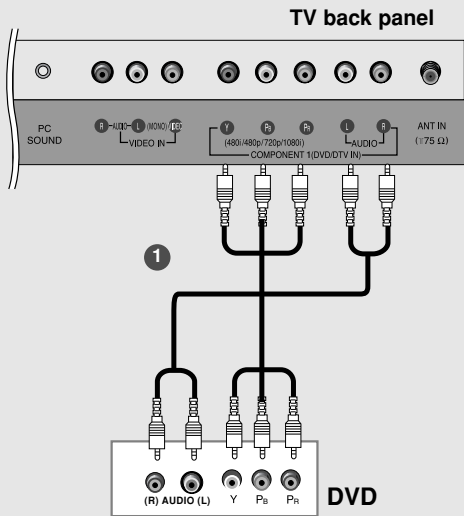

- 1 Connect the video outputs (Y, Pb, Pr) of the DVD to the **COMPONENT DVD IN (Y, Pb, Pr)** jacks on the set.
- 2 Connect the audio outputs of the DVD to the **AUDIO** input jacks on the set.
- 3 Turn on the DVD player, insert a DVD.
- 4 Select **Component1** input source with using the **TV/AV** button on the remote control.
- If connected to **COMPONENT2 IN** select **Component2** input source.
- 5 Refer to the DVD player's manual for operating instructions.



• Component Input ports

To get better picture quality, connect a DVD player to the component input ports as shown below.

Video output ports on DVD player	Y	Pb	Pr
	Y	B-Y	R-Y
	Y	Cb	Cr
Component ports on the TV	Y	Pb	Pr
	Y	Pb	Pr

TV side panel

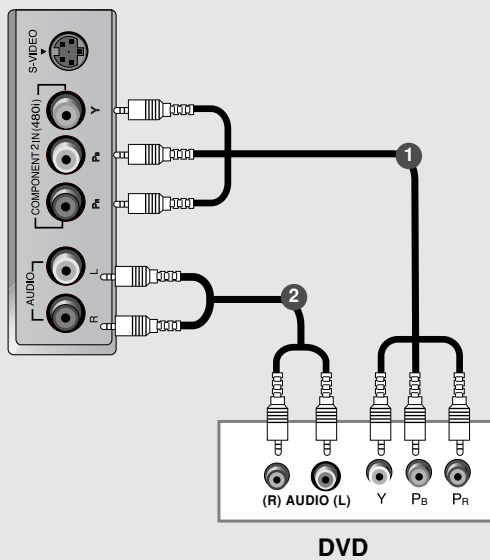

When connecting with a S-Video cable

TV side panel

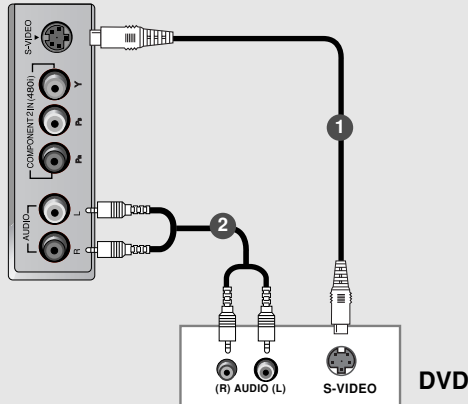

- 1 Connect the S-VIDEO output of the DVD to the **S-VIDEO** input on the set.
- 2 Connect the audio outputs of the DVD to the **AUDIO** input jacks on the set.
- 3 Turn on the DVD player, insert a DVD.
- 4 Select **S-Video** input source with using the **TV/AV** button on the remote control.
- 5 Refer to the DVD player's manual for operating instructions.

DVD Output Setup

The TV has a special signal output capability which allows you to hook up a second TV or monitor.

- 1 Connect the second TV or monitor to the TV's **DVD OUT (VIDEO)** and **DVD OUT (AUDIO)** jacks.
 - 2 See the Operating Manual of the second TV or monitor for further details regarding that device's input settings.
- 1 Connect the second TV or monitor to the TV's **DVD OUT (VIDEO)** and **OPTICAL DIGITAL SOUND OUT** jacks.
 - 2 See the Operating Manual of the second TV or monitor for further details regarding that device's input settings.

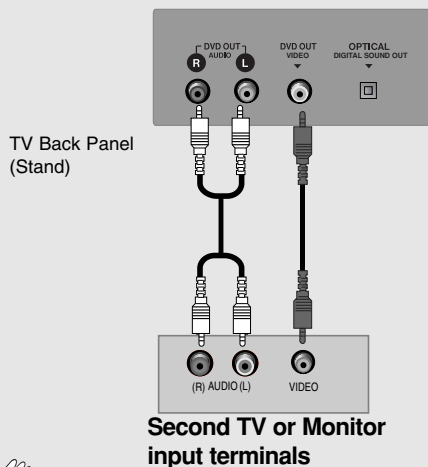

OR

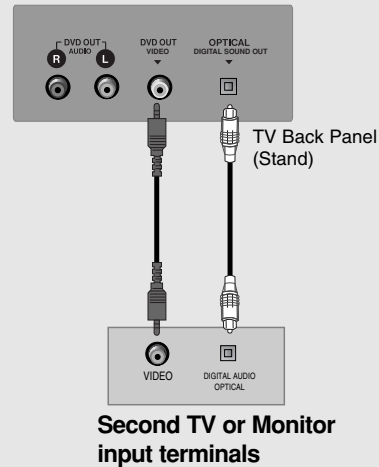

Note

- a. If your second TV or monitor has no optical digital audio input jack, it's impossible to use DVD digital sound output.
- b. Do not look into the optical output port. Looking at the laser beam may damage your vision.
- c. If your external audio equipment has a digital audio input optical port, you can connect it to your TV.

Installation

External Equipment Connections

DTV Setup

When connecting with a component cable

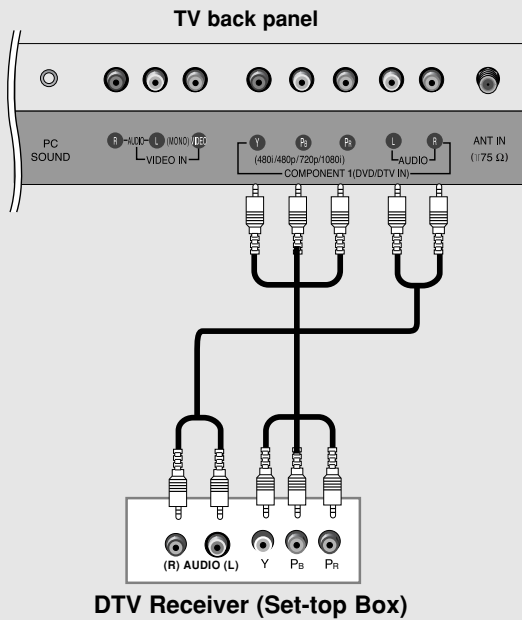

- 1 Connect the video outputs (Y, Pb, Pr) of the digital set-top box to the **COMPONENT DVD IN (Y, Pb, Pr)** jacks on the set.
- 2 Connect the audio outputs of the digital set-top box to the **AUDIO** input jacks on the set.
- 3 Turn on the digital set-top box. (Refer to the owner's manual for the digital set-top box.)
- 4 Select **Component1** input source with using the **TV/AV** button on the remote control.

PC Setup

- 1 Connect the TV to the PC with the PC cable.
- 2 Connect the PC audio output to the TV's **PC SOUND** input.
- 3 Turn on the PC.
- 4 Use the **TV/AV** button on the remote control to select **PC**.

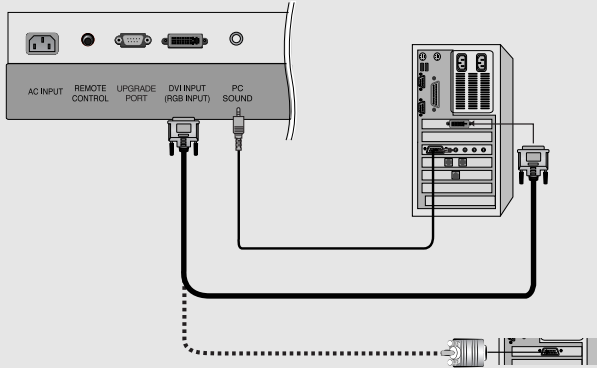

NOTE

Connect the signal cable (DVI-D cable, Not DVI to D-Sub cable) from the DVI output socket of the PC to the DVI input socket of the set when using a PC with DVI output. In some video cards, DVI-Analog output may not be supported.

Monitor Display Specifications

MODE	Resolution	Horizontal Frequency(kHz)	Vertical Frequency(Hz)
VGA	640x480	31.4	60
SVGA	800x600	37.8	60
XGA	1024x768	48.3	60
WXGA	1280x768	47.6	60
	1360x768	47.6	60



Note

- a. For optimum picture quality, use standard WXGA 1360x768 computer output at a 60Hz refresh rate. Using other formats (VGA, SVGA, etc.) or refresh rates may result in reduced picture quality. (To change the computer video output format, please refer to the operating manual for the computer you are using).
- b. If the message **Out of range** appears on the screen, adjust the PC output to a format listed in the **Monitor Display Specifications** table.
- c. The synchronization input form for Horizontal and Vertical frequencies is separate.

DPM (Display Power Management) mode

If the PC goes to power saving mode, the monitor automatically switches to DPM mode.
If you don't use the PC cable provided, DPM mode may not work.

Power Cord Connection

- Connect the power cord correctly as shown.

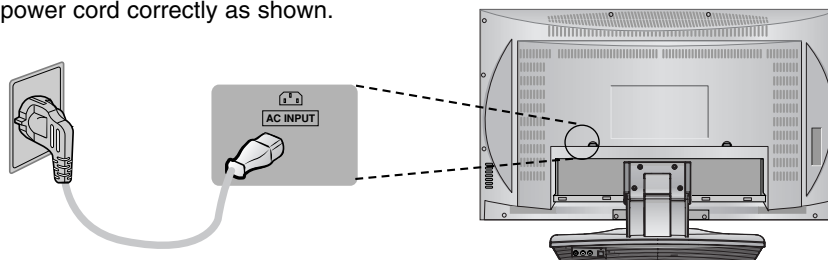

Operation

Basic Operation

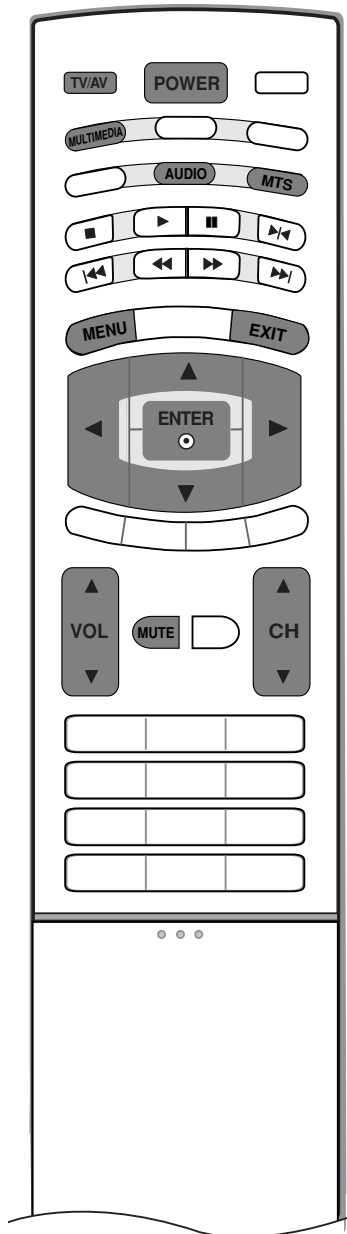

Turning On/Off the TV

- 1 First, make all equipment connections. Connect the AC power cord into the TV, then plug the power cord into a wall outlet. Press the **POWER** button located on the TV to turn on the TV. The power indicator will light.
 - In the standby mode, press the **POWER**, **CH ▲ / ▼**, **TV/AV**, **MULTIMEDIA** or number buttons on the remote control to turn on the TV.
- 2 If you want to turn the TV off, press the **POWER** button located on the remote control. If you intend to be away on vacation, disconnect the plug from the wall outlet.

Volume Adjustment

- 1 Press the **VOL ▲ / ▼** button to adjust the volume.
- 2 If you want to switch the sound off, press the **MUTE** button. You can cancel this function by pressing the **MUTE**, **VOL ▲ / ▼**, **AUDIO** or **MTS** button.

Programme selection

- 1 Press the **CH ▲ / ▼** or **NUMBER** buttons to select a programme number.

On screen language selection

- 1 Press the **MENU** button and then **▲ / ▼** button to select the **Setup** menu.
- 2 Press the **▶** button and then **▲ / ▼** button to select **Language**.
- 3 Press the **▶** button and then **▲ / ▼** button to select your desired language. All the on screen displays will appear in the selected language.
- 4 Press the **ENTER** button.
- 5 Press the **EXIT** button to return to normal TV viewing.

Operation

How to adjust the OSD screen

- 1 Press the **MENU** button and then **▲** / **▼** button to display each menu.
- 2 Press the **▶** button and then **▲** / **▼** button to select a menu item.
- 3 Change the setting of an item in the sub or pull-down menu with **◀** / **▶** button.
You can move to the higher level menu by pressing the **ENTER** or **MENU** button.

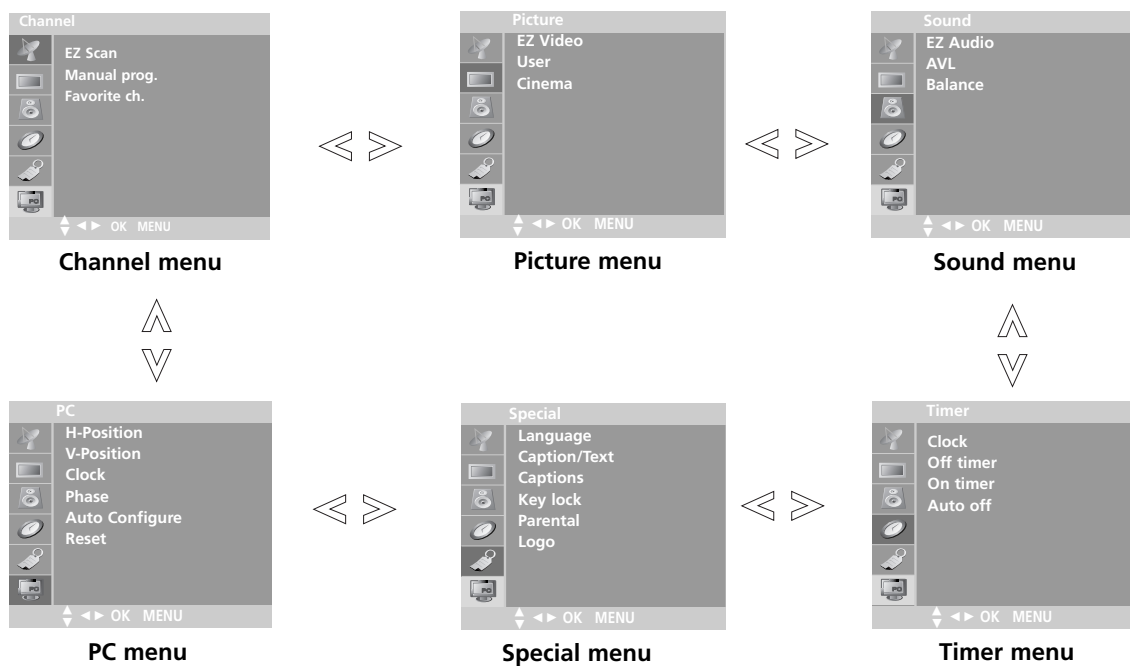

Note

In the **TV**, **Video**, **S-Video**, **DVD**, **Component 1**, **Component 2** and mode, the PC menu(option) is not displayed.

Setting up TV stations

Memorizing the Channels with EZ scan

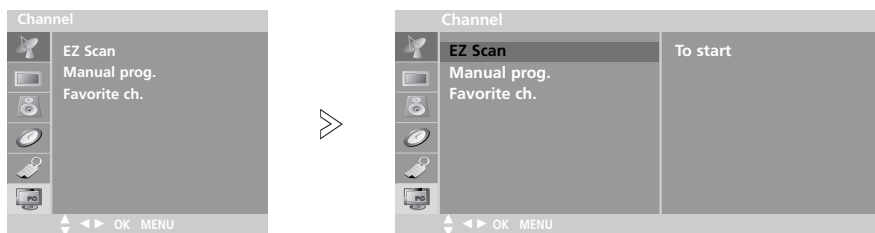

- For Auto program to work, the programming source must be connected to the TV and the TV must be receiving programming signals either over-the-air or from a cable-type service provider.

- 1 Press the **MENU** button and then use **▲ / ▼** button to select the **Channel** menu.
- 2 Press the **▶** button and then use **▲ / ▼** button to select **EZ Scan**.
- 3 Press the **▶** button to begin the channel search.
 - Wait for auto program to complete the channel search cycle before choosing a channel. The TV scans for over-the-air channels and then channels provided by a cable service.



Note

- a. When the channel search is complete, use the **▲ / ▼** buttons to review the memorized channels.
- b. If you press the **ENTER** button in auto programming, the function will stop and only channels programming up to that time will remain.
- c. Auto program function can memorize only the channels which are being received at that time.

Add/Delete Channels with Manual program

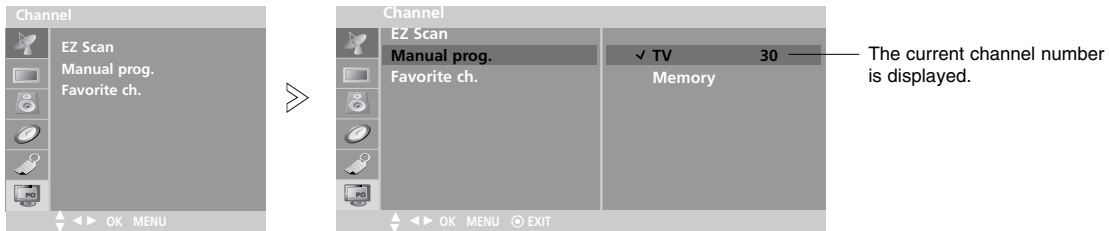

- You can manually include or erase individual channels.

- 1 Press the **MENU** button and then use **▲ / ▼** button to select the **Channel** menu.
- 2 Press the **▶** button and then use **▲ / ▼** button to select **Manual prog.**
- 3 Press the **▶** button and then use **◀ / ▶** button to select a channel you want to add to memory or erase.
- 4 Press the **▼** button and then use **◀ / ▶** button to select **Memory (add)** or **Erase (delete)**.
- 5 Press the **ENTER** button to save. The current channel is added to Memory or Erased from the channel list.

Favorite Channels Setup

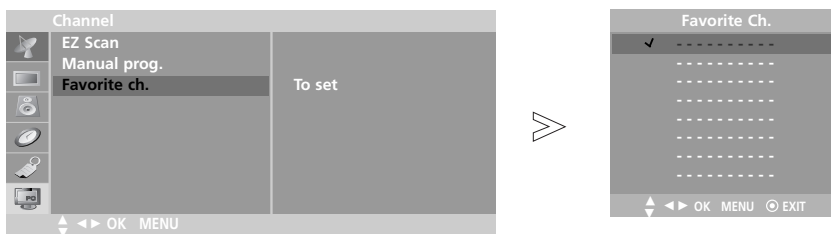

- *Favorite Channel lets you quickly tune in up to 8 channels of your choice without having to wait for the TV to scan through all the in-between channels.*

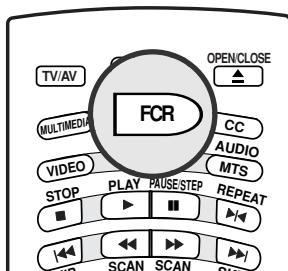

- 1 Press the **MENU** button and then use **▲ / ▼** button to select the **Channel** menu.
- 2 Press the **▶** button and then use **▲ / ▼** button to select **Favorite ch.**
- 3 Press the **▶** button and then use **▲ / ▼** button to select the first favorite channel position.
- 4 Use the **◀ / ▶** button to set the desired channel number for first favorite channel.
- 5 Repeat steps 3 to 4 to memorize other channels.
- 6 Press the **ENTER** button to save.

Picture Menu Options

EZ Video

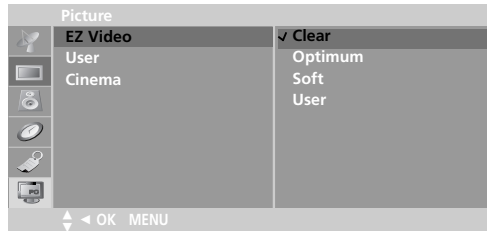
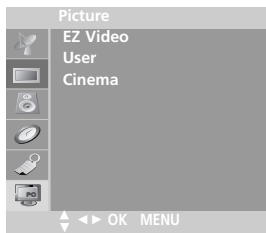

- This function adjusts the TV for the best picture appearance.

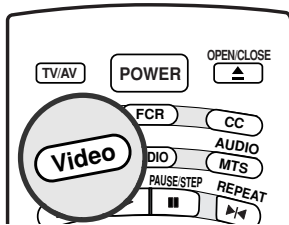

- 1 Press the **MENU** button and then **▲** / **▼** button to select the **Picture** menu.
- 2 Press the **▶** button and then **▲** / **▼** button to select **EZ Video**.
- 3 Press the **▶** button and then **▲** / **▼** button to select a picture setting on the **EZ Video** menu.
- 4 Press the **ENTER** button to save.

Manual Picture Control (User option)

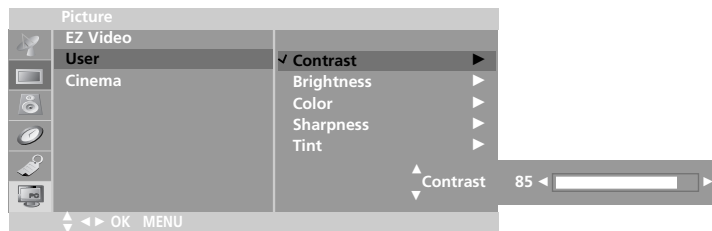
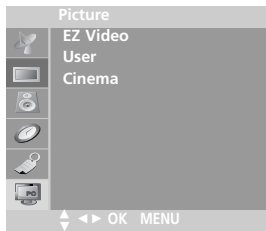

- You can adjust picture contrast, brightness, color, sharpness and tint to the levels you prefer.

- 1 Press the **MENU** button and then **▲** / **▼** button to select the **Picture** menu.
- 2 Press the **▶** button and then use **▲** / **▼** button to select **User**.
- 3 Press the **▶** button and then use **▲** / **▼** button to select the desired picture option (**Contrast, Brightness, Color, Sharpness, Tint**).
- 4 Use the **▲** / **▼** button to make appropriate adjustments.
 - Contrast, Brightness, Color, and Sharpness are adjustable from 0 to 100.
 - Tint is adjustable from - 50 to + 50.
- 5 Press the **ENTER** button to save.



Note

- a. Only **Contrast** and **Brightness** are displayed in PC mode.

Picture Menu Options

Cinema Mode Setup

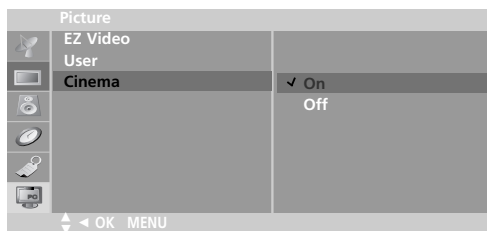
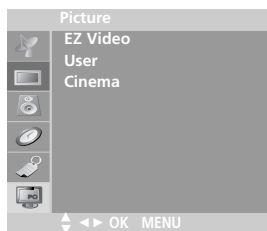

- Sets up the TV for the best picture appearance for viewing movies.

- 1 Press the **MENU** button and then use **▲** / **▼** button to select the **Picture** menu.
- 2 Press the **▶** button and then use **▲** / **▼** button to select **Cinema**.
- 3 Press the **▶** button and then use **▲** / **▼** button to select **On** or **Off**.
- 4 Press the **ENTER** button to save.

Picture format (ARC-Aspect Ratio Correction)

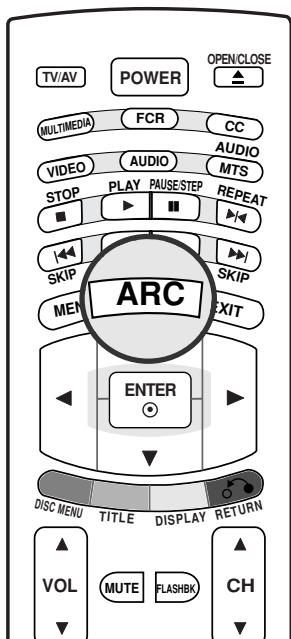

- You can watch TV in various picture formats; **16:9, Zoom, 4:3**.
Repeatedly press the **ARC** button to select your desired picture format.

- **16:9**

You can enjoy the cinema (the picture format of 16:9) or general TV programme through the 16:9 mode.

The screen 16:9 is viewed just like that but the screen 4:3 is magnified to the left and right so that the screen 16:9 is full.

- **Zoom**

You can enjoy the cinema in a vast screen through the Zoom mode.

The screen 4:3 is magnified to the upper / lower and left / right sides so that the screen 16:9 is full. The bottom and top of the picture may be lost.

- **4:3**

This picture format is 4 to 3 of general TV.



Note

- a. **Zoom** is not available in PC mode.



Sound Menu Options

EZ Audio

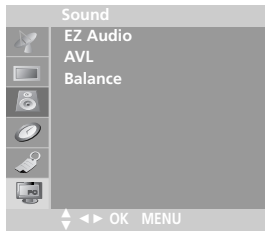

- This function lets you enjoy the best sound without any special adjustment because the TV selects the appropriate sound option based on the program content.

- 1 Press the **MENU** button and then **▲ / ▼** button to select the **Sound** menu.
- 2 Press the **▶** button and then **▲ / ▼** button to select **EZ Audio**.
- 3 Press the **▶** button and then use the **▲ / ▼** button to select the appropriate sound option; **Flat, Music, Movie, Sports**.
- 4 Press the **ENTER** button to save.

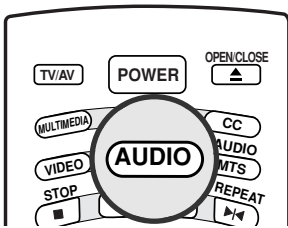

Equalizer Adjustments

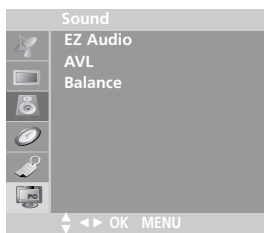

- 1 Press the **MENU** button and then **▲ / ▼** button to select the **Sound** menu.
- 2 Press the **▶** button and then **▲ / ▼** button to select **EZ Audio**.
- 3 Press the **▶** button and then use the **▲ / ▼** button to select **User**.
- 4 Press the **▶** button and then use the **◀ / ▶** button to select the band you want to adjust. Then, use the **▲ / ▼** button to adjust the band level.
- 5 Press the **ENTER** button to save.



Sound Menu Options

AVL (Auto Volume Leveler)

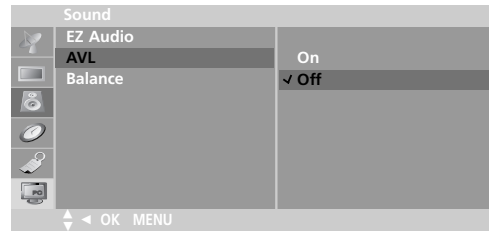
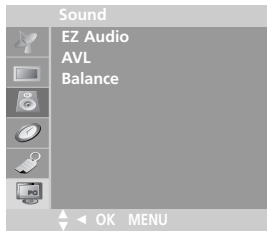

- AVL (Auto Volume Leveler) maintains an equal volume level automatically even if the programme is changed.

- 1 Press the **MENU** button and then **▲ / ▼** button to select the **Sound** menu.
- 2 Press the **▶** button and then **▲ / ▼** button to select **AVL**.
- 3 Press the **▶** button and then use the **▲ / ▼** button to select **On** or **Off**.
- 4 Press the **ENTER** button to save.

Sound Balance

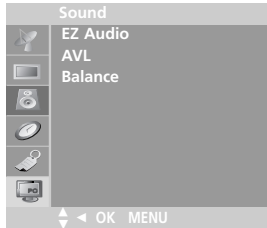

- 1 Press the **MENU** button and then **▲ / ▼** button to select the **Sound** menu.
- 2 Press the **▶** button and then **▲ / ▼** button to select **Balance**.
- 3 Press the **▶** button and then use the **◀ / ▶** button to adjust the sound balance.
 - Balance is adjustable from Left 50 to Right 50.
- 4 Press the **ENTER** button to save.

Stereo/SAP Broadcasts Setup

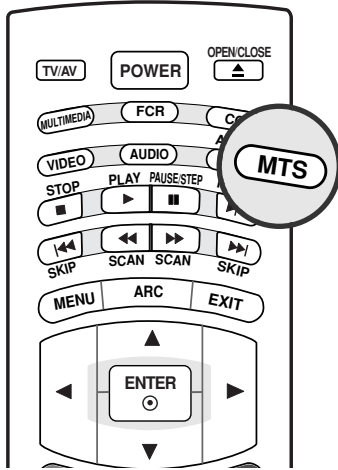

- The TV can receive MTS stereo programs and any SAP (Secondary Audio Program) that accompanies the stereo program, if the broadcaster transmits an additional sound signal as well as the original one.
- Mono: The primary language is heard from left and right speakers. Signal mode is mono.
- Stereo: The primary language is heard from left and right speakers. Signal mode is stereo.
- SAP: The secondary language is heard from left and right speakers.

1. Press the **MTS** button repeatedly.

- Select mono sound mode if the signal is not clear or in poor signal reception areas.
- **Stereo, SAP** mode are available only if included on the broadcast signal.

◀ Timer menu Options

Auto Clock Setup

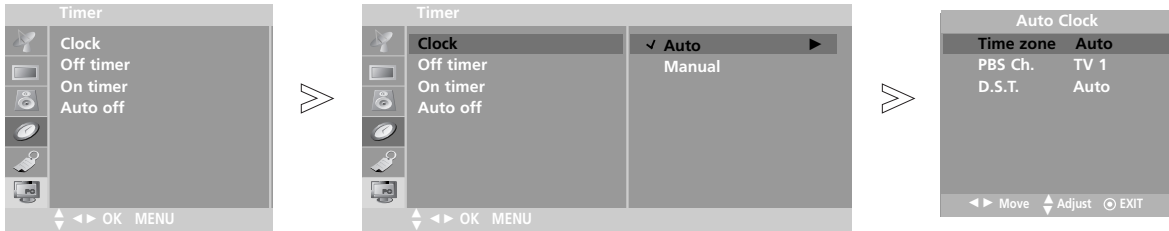

- The time can be automatically set using information from your local PBS TV station. The PBS channel signal includes information for the correct time and daylight savings time.

- 1 Press the **MENU** button and then use ▲ / ▼ button to select the **Timer** menu.
- 2 Press the ► button and then use ▲ / ▼ button to select **Clock**.
- 3 Press the ► button and then use ▲ / ▼ button to select **Auto**.
- 4 Press the ► button and then use ▲ / ▼ button to select the time zone for your viewing area. Your choices are: **Auto**, **E.S.T.** (Eastern Standard Time), **C.S.T.** (Central Standard Time), **M.S.T.** (Mountain Standard Time), **P.S.T.** (Pacific Standard Time), **Alaska**, and **Hawaii**.
- 5 Press the ► button and then use ▲ / ▼ button to set **PBS channel**.
- 6 Press the ► button and then use ▲ / ▼ button to set **D.S.T.** (Daylight Savings Time) **Auto**, **Off** or **On**, depending on whether or not your viewing area observes Daylight Savings Time.
- 7 Press the **ENTER** button to save.

Manual Clock Setup

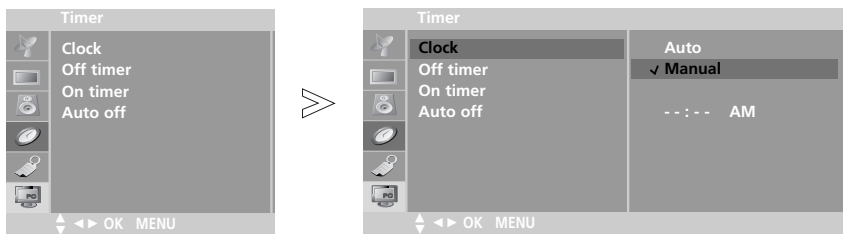

- If the time on the clock is incorrect, reset the clock manually.

- 1 Press the **MENU** button and then ▲ / ▼ button to select the **Timer** menu.
- 2 Press the ► button and then ▲ / ▼ button to select **Clock**.
- 3 Press the ► button and then ▲ / ▼ button to select **Manual**.
- 4 Press the ► button and then ▲ / ▼ button to set the hour.
- 5 Press the ► button and then ▲ / ▼ button to set the minute.
- 6 Press the **ENTER** button to save.

On/Off Timer Setup

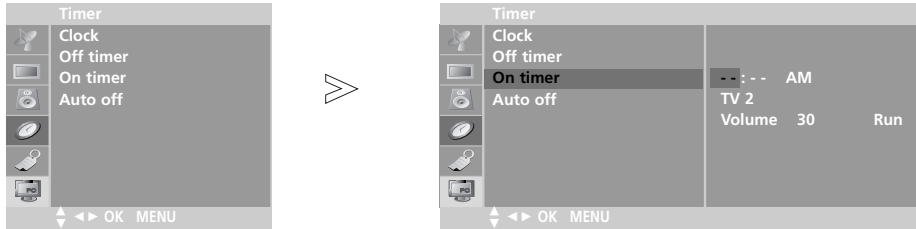

- *Timer function operates only if current time is set.*
- *Off-Timer function overrides On-Timer function if they are set to the same time.*
- *The TV must be in standby mode for the On-Timer to work.*
- *If you don't press any button within 2 hours after turning on the TV with the On-Timer function, the TV will automatically revert to standby mode.*

- 1** Press the **MENU** button and then use **▲ / ▼** button to select the **Timer** menu.
- 2** Press the **▶** button and then use **▲ / ▼** button to select **Off timer** or **On timer**.
- 3** Press the **▶** button and then use **▲ / ▼** button to set the hour.
- 4** Press the **▶** button and then use **▲ / ▼** button to set the minutes.
- 5 For On timer function only:**
Press the **▶** button and then use **▲ / ▼** button to set the channel at turn-on. Then, press the **▶** button and then use **▲ / ▼** button to set the turn-on sound level.
- 6** Press the **▶** button and then use **▲ / ▼** button to select **Run** or **Hold**.
 - **Hold:** Off timer/On timer will not work.
 - **Run:** Off timer/On timer are active.
- 7** Press the **ENTER** button to save.

Sleep Timer Setup

- *The Sleep Timer turns the TV off at a preset time.*

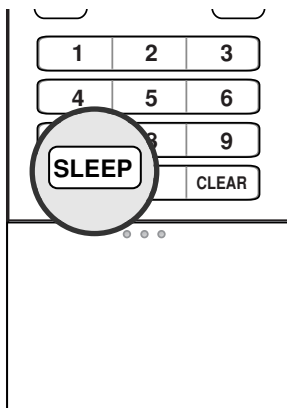

- 1** Press the **SLEEP** button repeatedly to select the number of minutes. First the **Sleep ---** option appears on the screen, followed by the following sleep timer options: 10, 20, 30, 60, 90, 120, 180, and 240 minutes.
- 2** The timer begins to count down from the number of minutes selected.
- 3** To check the remaining minutes before the TV turns off, press the **SLEEP** button once.
- 4** To cancel the Sleep Timer, press the **SLEEP** button repeatedly until **Sleep ---** appears.

◀ Timer menu Options

Auto off

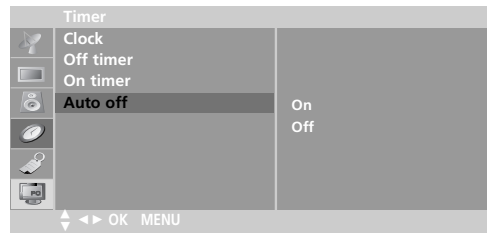

- If you select **On** on the **Auto off** menu, the set will automatically switch itself to standby mode approximately ten minutes after a TV station stops broadcasting.
- In the **Component, DVD** or **PC** mode, **Auto off** is not available.

- 1** Press the **MENU** button and then **▲ / ▼** button to select the **Timer** menu.
- 2** Press the **▶** button and then **▲ / ▼** button to select **Auto off**.
- 3** Press the **▶** button and then **▲ / ▼** button to select **On** or **Off**.
- 4** Press the **ENTER** button to save.

Special Menu Options

Closed Captions

Closed captioning is a process which converts the audio portion of a television program into written words which then appear as subtitles on the television screen. Closed captions allow viewers to read the dialogue and narration of television programs.

Using Closed Captions

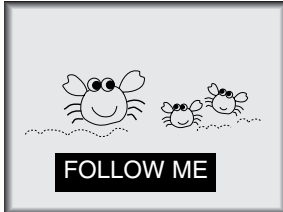

Captions are the subtitles of the dialogue and narration of television programs. For prerecorded programs, program dialogue can be arranged into captions in advance. Its possible to caption a live program by using a process called real-time captioning, which creates captions instantly. Real-time captioning is normally done by professional reporters using a machine shorthand system and computer for translation into English.

Captioning is an effective system for the hearing-impaired, and it can also aid in teaching language skills.

- The picture at left shows a typical caption.

Caption Tips

- Not all TV broadcasts include closed caption signals.
- Sometimes TV stations broadcast four different caption signals on the same channel. By selecting **From CC 1 to CC 4**, you can choose which signal you view. **CC 1** is usually the signal with the captions, while **Another mode** might show demonstration or programming information.
- Your TV might not receive caption signals normally in the following situations.

1. Poor reception conditions are encountered:



- **IGNITION:**

Picture may flutter, drift, suffer from black spots, or horizontal streaking. Usually caused by interference from automobile ignition systems, neon lamps, electrical drills, and other electrical appliances.



- **GHOSTS:**

Ghosts are caused when the TV signal splits and follows two paths. One is the direct path and the other is reflected off tall buildings, hills or other objects. Changing the direction or position of the antenna may improve reception.



- **SNOW:**

If your receiver is located at the weak, fringe area of a TV signal, your picture may be marred by small dots. It may be necessary to install a special antenna to improve the picture.

2. An old, bad, or illegally recorded tape is being played.
3. Strong, random signals from a car or airplane interfere with the TV signal.
4. The signal from the antenna is weak.
5. The program wasn't captioned when it was produced, transmitted, or taped.

Special Menu Options

Caption/Text

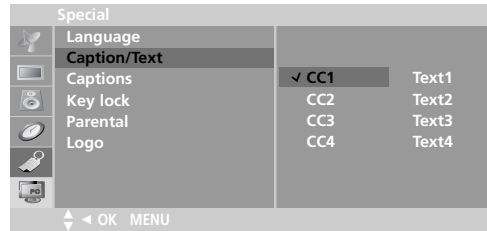
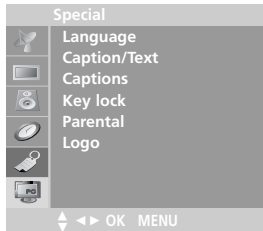

- 1 Press the **MENU** button and then use **▲ / ▼** button to select the **Special** menu.
- 2 Press the **▶** button and then use **▲ / ▼** button to select **Caption / Text**.
- 3 Press the **▶** button and then use **▲ / ▼** button to select caption: **CC1, CC2, CC3, CC4, Text1, Text2, Text3, or Text4**.

- **CAPTION**

The term for the words that scroll across the bottom of the TV screen; usually the audio portion of the program provided for the hearing impaired.

- **TEXT**

The term for the words that appear in a large black frame and almost cover the entire screen; usually messages provided by the broadcaster.

- 4 Press the **ENTER** button to save.

Captions

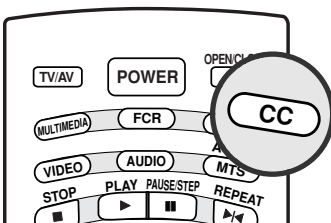

- 1 Use the **CC** button repeatedly to select Caption **Off, EZ Mute** or **On**.
 - **EZ Mute** shows the selected captions option (if available on program) when the TV sound is muted
- 2 Press the **ENTER** button to save.

Key Lock

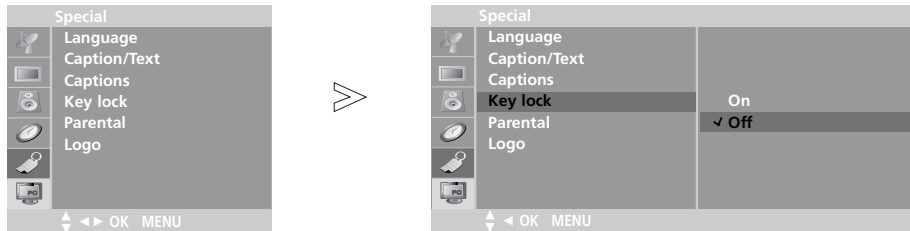

- The TV can be set up so that it can only be used with the remote control to prevent unauthorized viewing.

- 1 Press the **MENU** button and then ▲ / ▼ button to select the **Special** menu.
- 2 Press the ► button and then ▲ / ▼ button to select **Key lock**.
- 3 Press the ► button and then ▲ / ▼ button to select **On** or **Off**.
- 4 Press the **ENTER** button to save.

Lightening Logo Display Lamp

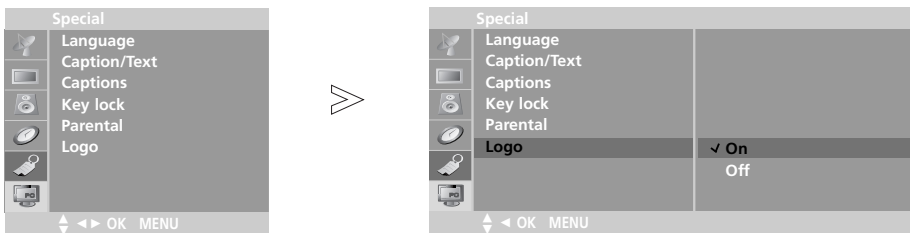

- If you select on, "Liquid Crystal Display" of TV front panel turns on.

- 1 Press the **MENU** button and then ▲ / ▼ button to select the **Special** menu.
- 2 Press the ► button and then use ▲ / ▼ button to select **Logo**.
- 3 Press the ► button and then ▲ / ▼ button to select **On** or **Off**.
- 4 Press the **ENTER** button to save.



Special Menu Options

Parental Menu Options

Parental Control can be used to block specific channels, ratings and other viewing sources.

The Parental Control Function (V-Chip) is used to block program viewing based on the ratings sent by the broadcast station. The default setting is to allow all programs to be viewed. Viewing can be blocked by the type of program and by the categories chosen to be blocked. It is also possible to block all program viewing for a time period. To use this function, the following must be set :

1. Ratings and categories to be blocked.
2. Set a password
3. Enable the lock

V-Chip rating and categories

Rating guidelines are provided by broadcast stations. Most television programs and television movies can be blocked by TV Rating and/or Individual Categories. Movies that have been shown at the theaters or direct-to-video movies use the Movie Rating System (MPAA) only.

For Movies previously shown in theaters :

Movie Ratings :

- Unblocked
- G and Above (general audience)
- PG and Above (parental guidance suggested)
- PG-13 and Above (13 years and older)
- R and above (restricted)
- NC-17 and Above (18 years and older)
- X (adult)

If you set PG-13 and Above : G and PG movies will be available , PG-13, R, NC-17 and X will be blocked.

For Television programs including made-for-TV movies:

General TV Ratings:

- Unblocked
- TV-G and Above (general audience) (individual categories do not apply)
- TV-PG and Above (parental guidance suggested)
- TV-14 and Above (14 years and older)
- TV-MA (mature audience)

Children TV Ratings:

- Unblocked
- TV-Y and Above (youth) (individual content categories do not apply)
- TV-Y7 (youth, 7 years and up)

Content Categories:

- Dialog - sexual dialogue (applies to TV-PG and Above, TV-14)
- Language - adult language (applies to TV-PG and Above, TV-14 and Above, TV-MA)
- Sex scenes - sexual situations (applies to TV-PG and Above, TV-14 and Above, TV-MA)
- Violence (applies to TV-PG and Above, TV-14 and Above, TV-MA)
- F Violence - fantasy violence (applies only to TV-Y7)
- No Rating (blocks all viewing)

For Canadian English/French language rating system:

Canadian English language rating system:

- C and Above (Children)
- C8+ (8 years and older)
- G and Above (General programming. Suitable for all audiences.)
- PG and Above (Parental guidance suggested)
- 14+ (Viewer 14 years and older)
- 18+ (Adult programming)

Canadian French language rating system:

- G and Above (General)
- 8 ans+ (8 years and older)
- 13 ans+ (13 years and older)
- 16 ans+ (16 years and older)
- 18 ans+ (Adults only)



PC Menu Options

After setup, be sure to select **PC** source to see the PC image the on TV screen.

Auto Configure

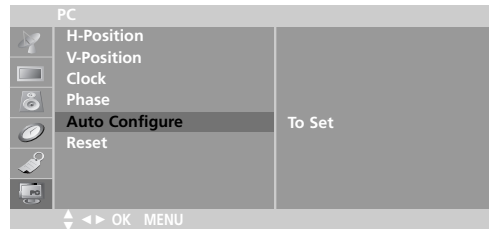
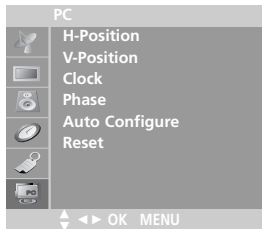

- Automatically adjusts the screen position, clock, and phase. (The displayed image will disappear for a few seconds while Auto-configuration is in progress.)

- 1 Press the **MENU** button and then use the **▲ / ▼** button to select the **PC** menu.
- 2 Press the **▶** button and then use the **▲ / ▼** button to select **Auto Configure**.
- 3 Press the **▶** button to start **Auto Configure**.

H-Position / V-Position

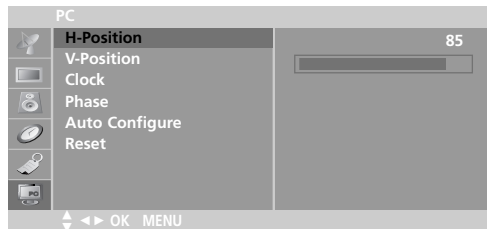
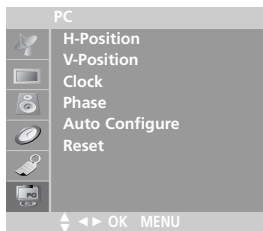

- **H position / V Position**
This function is to adjust picture to left/right and up/down as you prefer.

- 1 Press the **MENU** button and then use the **▲ / ▼** button to select the **PC** menu.
- 2 Press the **▶** button and then use the **▲ / ▼** button to select **H-Position** or **V-Position**.
- 3 Use the **◀ / ▶** button to make appropriate adjustments.



PC Menu Options

Clock / Phase

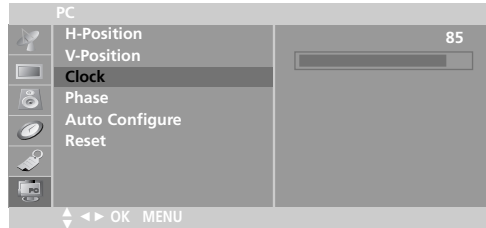
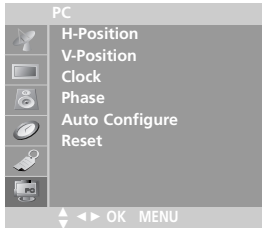

• Clock

This function is to minimize any vertical bars or stripes visible on the screen background. And the horizontal screen size will also change.

• Phase

This function allows you to remove any horizontal noise and clear or sharpen the image of characters.

- 1 Press the **MENU** button and then use the **▲ / ▼** button to select the **PC** menu.
- 2 Press the **▶** button and then use the **▲ / ▼** button to select **Clock** or **Phase**.
- 3 Use the **◀ / ▶** button to make appropriate adjustments.
- 4 Press the **ENTER** button to save.

Reset

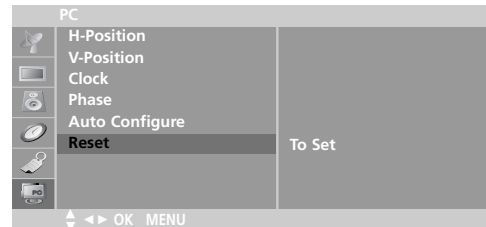
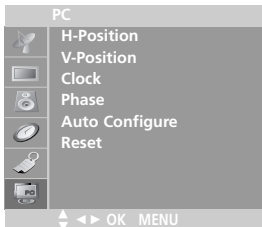

- Returns to the default settings programmed at the factory; default settings cannot be changed.

- 1 Press the **MENU** button and then use the **▲ / ▼** button to select the **PC** menu.
- 2 Press the **▶** button and then use the **▲ / ▼** button to select **Reset**.
- 3 Press the **▶** button to start **Reset**.

DVD operation

Notes on Discs

Symbol Used in this Manual

- DVD-V** DVD and finalized DVD±R/RW
 - VCD** Video CDs
 - CD** Audio CDs
 - MP3** MP3 Discs
 - WMA** WMA Discs
 - JPEG** JPEG Discs
 - DivX** DivX Discs
- ⊘ may appear on your TV display during operation and indicates that the function explained in this owner's manual is not available on that specific DVD video disc.

On handling discs

- Do not touch the playback side of the disc.

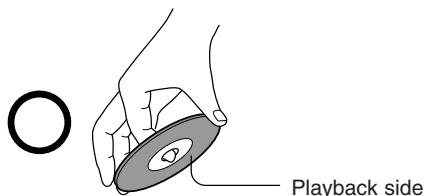

- Do not attach paper or tape to discs.



On cleaning discs

- Fingerprints and dust on the disc cause picture and sound deterioration. Wipe the disc from the center outwards with a soft cloth. Always keep the disc clean.

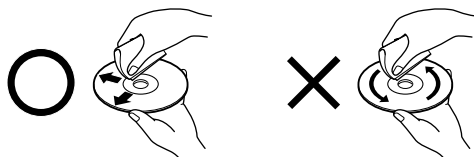

- Do not use any type of solvent such as thinner, benzene, commercially available cleaners or antistatic spray for vinyl LPs. It may damage the disc.

On storing discs

- Do not store discs in a place subject to direct sunlight or near heat sources.
- Do not store discs in places subject to moisture and dust such as a bathroom or near a humidifier.
- Store discs vertically in a case. Stacking or placing objects on discs outside of their case may cause warping.



Structure of disc contents

Normally, DVD video discs are divided into titles, and the titles are sub-divided into chapters. Video CDs and Audio CDs are divided into tracks.

DVD video disc

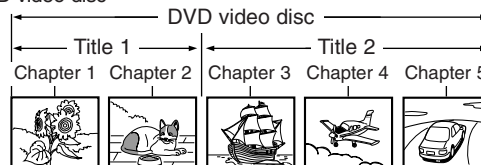

Video CD/Audio CD

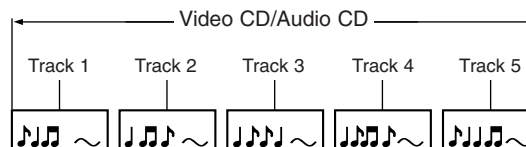

Each title, chapter or track is assigned a number, which is called "title number", "chapter number" or "track number" respectively. There may be discs that do not have these numbers.

- **Title:** When two or more movies are recorded on a disc, the disc is divided into two or more parts. Each part is called a "TITLE".
- **Chapter:** The titles can be subdivided into many sections. Each section is called a "CHAPTER".
- **Track:** An audio CD can contain several items. These are assigned to the tracks.

Notes

- If an MP3 or JPEG file CD is created using an incorrect method, the player may not be able to recognize it. If this happens, try reburning another CD after setting up the disc writing parameters correctly on your PC.

DVD operation

Notes on Discs

Types of Playable Discs

- DVD (8 cm / 12 cm disc)
- Video CD (VCD) (8 cm / 12 cm disc)
- Audio CD (8 cm / 12 cm disc)

In addition, this unit plays DivX file, DVD -R, DVD +R, DVD -RW, DVD +RW, Kodak Picture CDs, SVCD, and CD-R / CD-RW that contains audio titles, MP3, WMA, and/or JPEG files.

Notes

- Depending on the conditions of the recording equipment or the CD-R/RW (or DVD -R, DVD +R, DVD -RW, DVD +RW) disc itself, some CD-R/RW (or DVD -R, DVD +R, DVD -RW, DVD +RW) discs cannot be played on the unit.

Regional code of the DVD player and DVDs



This DVD player is designed and manufactured for playback of region "1" encoded DVD software. The region code on the labels of some DVD discs indicates which type of player can play those discs. This unit can play only DVD discs labeled "1" or "ALL". If you try to play any other discs, the message "Check Regional Code" will appear on the TV screen. Some DVD discs may not have a region code label even though their playback is prohibited by area limits.

Manufactured under license from Dolby Laboratories. "Dolby" and the double-D symbol are trademarks of Dolby Laboratories. "DTS" and "DTS Digital Surround" are trademarks of Digital Theater System, Inc.

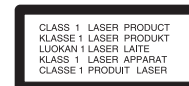

CAUTION:

This Digital Video Disc Player employs a Laser System. To ensure proper use of this product, please read this owner's manual carefully and retain for future reference should the unit require maintenance, contact an authorized service location (see service procedure).

Use of controls, adjustments, or the performance of procedures other than those specified herein may result in hazardous radiation exposure.

To prevent direct exposure to laser beam, do not try to open the enclosure. Visible laser radiation when open. **DO NOT STARE INTO BEAM.**

CAUTION: The apparatus should not be exposed to water (dripping or splashing) and no objects filled with liquids, such as vases, should be placed on the apparatus.

Screen Saver

The screen saver appears when you leave the DVD player in Stop mode for about five minutes. If the Screen Saver is displayed for five minutes, the DVD Player automatically turns itself off.

Last Scene Memory

This player memorizes last scene from the last disc that is viewed. The last scene remains in memory even if you remove the disc from the player or turn off the set. If you load a disc that has the scene memorized, the scene is automatically recalled.

Note:

This player does not memorize the scene of a disc if you switch off the player before commencing to play the disc.

DVD operation

DVD Menu options - LANGUAGE

By using the DVD menu, you can make various adjustments to items such as picture and sound. You can also set a language for the subtitles and the DVD menu, among other things.

Menu Language

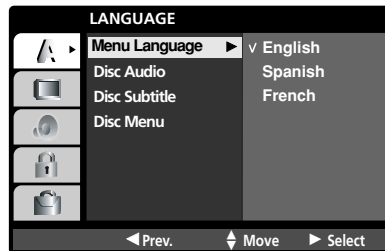

- Select your preferred language for the DVD menus and on screen displays messages.

- 1 Press the **MENU** button twice and then use the ▲ / ▼ button to select **Language**.
- 2 Press the ► button and then use ▲ / ▼ button to select **Menu Language**.
- 3 Press the ► button and then use ▲ / ▼ button to select your desired language.
- 4 Press the **ENTER** button.
The menus and on screen displays will appear in the selected language.
- 5 Press the **EXIT** button to resume normal playback.

Disc Audio / Disc Subtitle / Disc Menu

DVD-V



- Select the language you prefer for the **Disc Audio / Disc Subtitle / Disc Menu**.

- **Original:** Refers to the original language in which the disc was recorded.
- **Other:** To select another language, press number buttons then **OK** button to enter the corresponding 4-digit number according to the language code list in the **REFERENCE** chapter. (Refer to p.62) If you enter the wrong language code, press **CLEAR** button.

- 1 Press the **MENU** button twice and then use the ▲ / ▼ button to select **Language**.
- 2 Press the ► button and then use ▲ / ▼ button to select **Disc Audio / Disc Subtitle / Disc Menu**.
- 3 Press the ► button and then use ▲ / ▼ button to select your desired language.
- 4 Press the **ENTER** button.
- 5 Press the **EXIT** button to resume normal playback.

DVD operation

DVD Menu options - DISPLAY

Progressive Scan

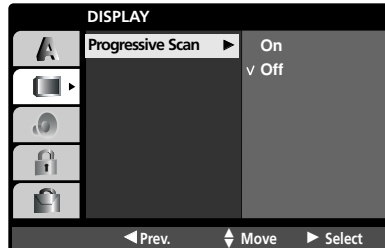

- *Progressive Scan Video provides the highest quality pictures with less flickering. Set **Progressive Scan** to **On**.*

- 1 Press the **MENU** button twice and then use the ▲ / ▼ button to select **DISPLAY**.
- 2 Press the ► button to select **Progressive Scan**.
- 3 Press the ► button and then use ▲ / ▼ button to select **On** or **Off**.
- 4 Press the **ENTER** button.
- 5 Press the **EXIT** button to resume normal playback.

DVD operation

DVD Menu options - AUDIO

Each DVD disc has a variety of audio output options.

Set the player's AUDIO options according to the type of audio system you use.

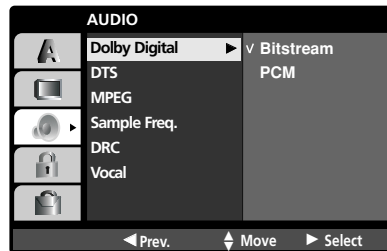

• **Bitstream:** Select **Bitstream** if you connect the DVD Player's DIGITAL OUT jack to an amplifier or other equipment with a Dolby Digital, DTS or MPEG decoder.

• **PCM (Pulse Code Modulation):** Select when connected to a two-channel digital stereo amplifier. DVDs encoded in Dolby Digital, DTS or MPEG will be automatically down-mixed to two-channel PCM audio.

- 1 Press the **MENU** button twice and then use the ▲ / ▼ button to select **AUDIO**.
- 2 Press the ► button and then use ▲ / ▼ button to select **Dolby Digital / DTS / MPEG**.
- 3 Press the ► button and then use ▲ / ▼ button to select **Bitstream** or **PCM**.
- 4 Press the **ENTER** button.
- 5 Press the **EXIT** button to resume normal playback.

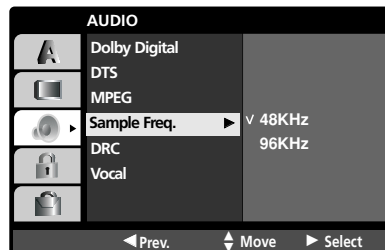

- If your receiver or amplifier is NOT capable of handling 96 kHz signals, select 48 kHz. When this choice is made, this unit automatically converts any 96 kHz signals to 48 kHz so your system can decode them.

If your receiver or amplifier is capable of handling 96 kHz signals, select 96 kHz. When this choice is made, this unit passes each type of signal through without any further processing.

Check the documentation for your amplifier to verify its capabilities.

- 1 Press the **MENU** button twice and then use the ▲ / ▼ button to select **AUDIO**.
- 2 Press the ► button and then use ▲ / ▼ button to select **Sample Freq.**
- 3 Press the ► button and then use ▲ / ▼ button to select **48KHz** or **96KHz**.
- 4 Press the **ENTER** button.
- 5 Press the **EXIT** button to resume normal playback.

DVD operation

DVD Menu options - AUDIO

DRC (Dynamic Range Control)

DVD-V DivX

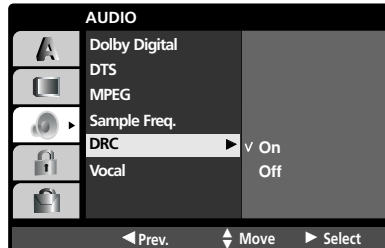

- With the DVD format, you can hear a program's soundtrack in the most accurate and realistic presentation possible, thanks to digital audio technology. However, you may wish to compress the dynamic range of the audio output (the difference between the loudest sounds and the quietest ones). This allows you to listen to a movie at a lower volume without losing clarity of sound. Set **DRC** to **On** for this effect.

- 1 Press the **MENU** button twice and then use the **▲ / ▼** button to select **AUDIO**.
- 2 Press the **▶** button and then use **▲ / ▼** button to select **DRC**.
- 3 Press the **▶** button and then use **▲ / ▼** button to select **On** or **Off**.
- 4 Press the **ENTER** button.
- 5 Press the **EXIT** button to resume normal playback.

Vocal

DVD-V



- Set to **On** only when a multi-channel karaoke DVD is playing. The karaoke channels on the disc mix into normal stereo sound.
- **Vocal** setting works when the **Dolby Digital** mode is set to "**PCM**" in the DVD menu.

- 1 Press the **MENU** button twice and then use the **▲ / ▼** button to select **AUDIO**.
- 2 Press the **▶** button and then use **▲ / ▼** button to select **Vocal**.
- 3 Press the **▶** button and then use **▲ / ▼** button to select **On** or **Off**.
- 4 Press the **ENTER** button.
- 5 Press the **EXIT** button to resume normal playback.

DVD operation

DVD Menu options - LOCK

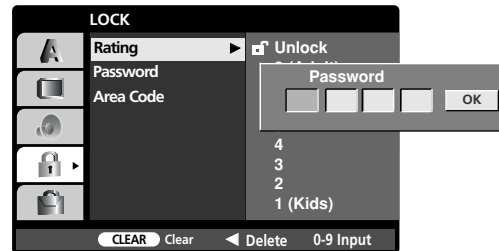
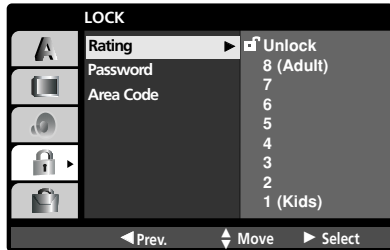

- Some movies contain scenes that may not be suitable for children to view. Many of these discs contain parental control information that applies to the complete disc or to certain scenes on the disc. Movies and scenes are rated from 1 to 8, depending on the country. Some discs offer more suitable scenes as an alternative.

The parental control feature allows you to block access to scenes below the rating you input, thereby preventing your children from being able to view material you believe is unsuitable.

- 1 Press the **MENU** button twice and then use the **▲ / ▼** button to select **LOCK**.
- 2 Press the **▶** button and then use **▲ / ▼** button to select **Rating**.
- 3 Press the **▶** button.
To access the **Rating**, you must input the 4-digit password you created. If you have not yet entered a password you are prompted to do so. Input a 4-digit password and press **OK** button. Enter it again and press **OK** button to verify. If you make a mistake before pressing **OK** button, press **CLEAR** button.
- 4 Select a rating from 1 to 8 using the **▲ / ▼** button.
Rating 1-8: Rating 1 has the most restrictions and rating 8 is the least restrictive.
Unlock : If you select unlock, parental control is not active and the disc plays in full.
- 5 Press the **ENTER** button.
- 6 Press the **EXIT** button to resume normal playback.



Note

- a. If you set a rating for the player, all disc scenes with the same rating or lower are played. Higher rated scenes are not played unless an alternate scene is available on the disc. The alternative must have the same rating or a lower one. If no suitable alternative is found, playback stops. You must enter the 4-digit password or change the rating level in order to play the disc.

Password (Security Code)

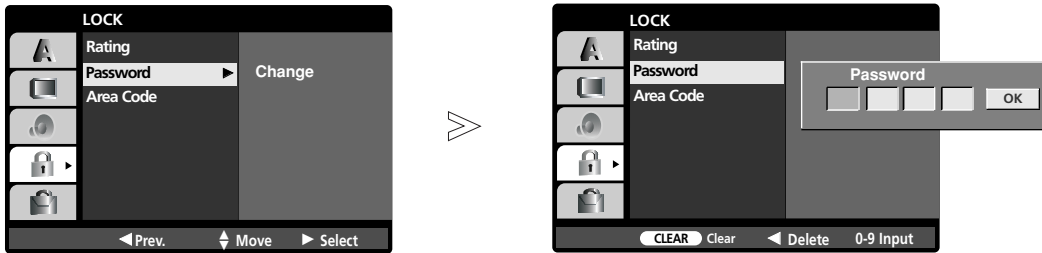

- You can enter or change password.

1 Press the **MENU** button twice and then use the **▲ / ▼** button to select **LOCK**.

2 Press the **▶** button and then use **▲ / ▼** button to select **Password**.

3 Press the **▶** and **ENTER** button.

In case of "New"

Input a 4-digit password and press **OK** button. Enter it again and press **OK** button to verify. If you make a mistake before pressing **OK** button, press **CLEAR** button.

In case of "Change"

1. Input the 4-digit password you created.

2. Input the new 4-digit password and press **OK** button. Enter it again and press **OK** button to verify. If you make a mistake before pressing **OK** button, press **CLEAR** button.

4 Press the **EXIT** button to exit the menu.

If you forget your Password

If you forget your password you can clear it using the following steps:

1. Press the **MENU** button twice to display the DVD menu.

2. Input the 6-digit number "**210499**" and the password is cleared.

3. Enter a new password as described above.

Area Code

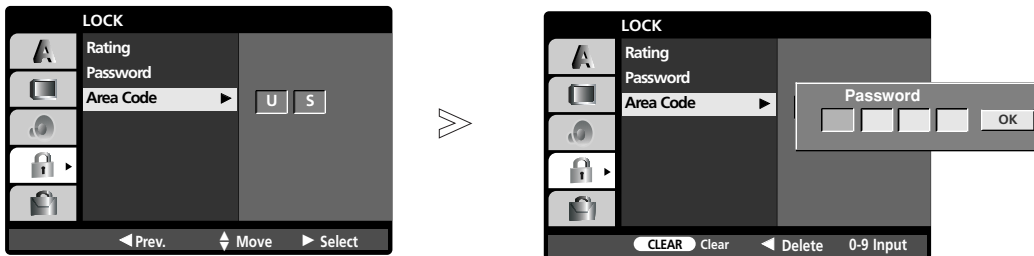

- Enter the code of the country/area whose standards were used to rate the DVD video disc, based on the list in the "**REFERENCE**" chapter. (Refer to p.62)

1 Press the **MENU** button twice and then use the **▲ / ▼** button to select **LOCK**.

2 Press the **▶** button and then use **▲ / ▼** button to select **Area Code**.

3 Press the **▶** button.

To access the **Area Code**, you must input the 4-digit password you created. If you have not yet entered a password you are prompted to do so.

Input a 4-digit password and press **OK** button. Enter it again and press **OK** button to verify. If you make a mistake before pressing **OK** button, press **CLEAR** button.

4 Select the first character using **▲ / ▼** button and press **ENTER** button.

5 Select the second character using **▲ / ▼** button and press **ENTER** button to confirm your country code selection.

6 Press the **EXIT** button to exit the menu.

DVD operation

DVD Menu options - OTHERS



- Set Playback Control (PBC) to **On** or **Off**.
On: Video CDs with **PBC** are played according to the **PBC**.
Off: Video CDs with **PBC** are played the same way as Audio CDs.

- 1 Press the **MENU** button twice and then use the **▲ / ▼** button to select **OTHERS**.
- 2 Press the **▶** button and then use **▲ / ▼** button to select **PBC**.
- 3 Press the **▶** button and then use **▲ / ▼** button to select **On** or **Off**.
- 4 Press the **ENTER** button.
- 5 Press the **EXIT** button to resume normal playback.

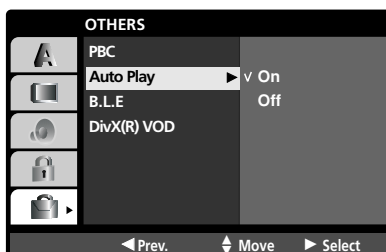

- You can set up the DVD Player so a DVD disc automatically starts playing whenever the DVD is inserted. If **Auto Play** mode is set to **On**, this DVD player will search for title that has the longest playback time and then play back the title automatically.

- 1 Press the **MENU** button twice and then use the **▲ / ▼** button to select **OTHERS**.
- 2 Press the **▶** button and then use **▲ / ▼** button to select **Auto Play**.
- 3 Press the **▶** button and then use **▲ / ▼** button to select **On** or **Off**.
- 4 Press the **ENTER** button.
- 5 Press the **EXIT** button to resume normal playback.



Note

- a. The Auto Play function may not work for some DVDs.
- b. When you load and play back again the same disc in the tray, Playback starts from the location where you stopped playback because **Last scene memory** function works prior to **Auto Play** function.

DVD operation

DVD Menu options - OTHERS

B.L.E (Black Level Extension)

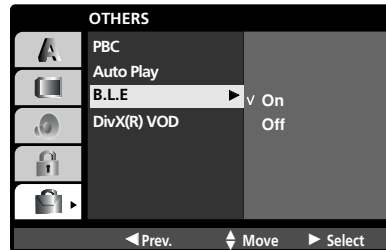

- Use it to extend the darkness part on the dark ness part on the screen.

- 1 Press the **MENU** button twice and then use the ▲ / ▼ button to select **OTHERS**.
- 2 Press the ► button and then use ▲ / ▼ button to select **B.L.E**.
- 3 Press the ► button and then use ▲ / ▼ button to select **On** or **Off**.
- 4 Press the **ENTER** button.
- 5 Press the **EXIT** button to resume normal playback.

DivX(R) VOD

DVD-V

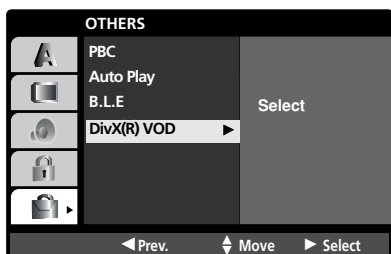

- You can show the DivX DRM (Digital Right Management) Registration code for your unit only.
The Registration code is used for VOD (Video-On-Demand) service agent. You can purchase or rental an encrypt movie file.

- 1 Press the **MENU** button twice and then use the **▲ / ▼** button to select **OTHERS**.
- 2 Press the **▶** button and then use **▲ / ▼** button to select **DivX(R) VOD**.
- 3 Press the **▶** and **ENTER** button.
- 4 Press the **EXIT** button to resume normal playback.



Note

a. If you rent the DivX VOD file, it has several options of viewing limits as show below.

- Display the number which you can watch the file.

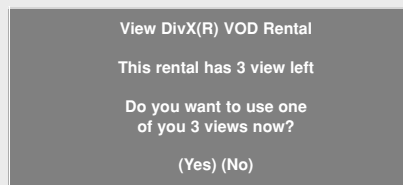

- The rental has been expired.

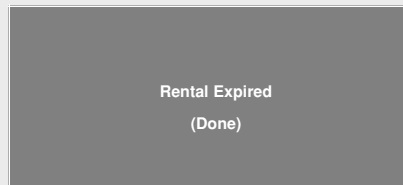

- Display the authorization error.

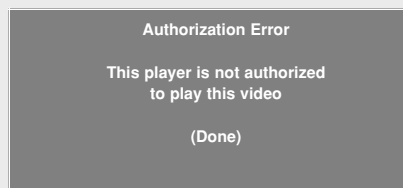

DVD operation

Playing a DVD or Video CD

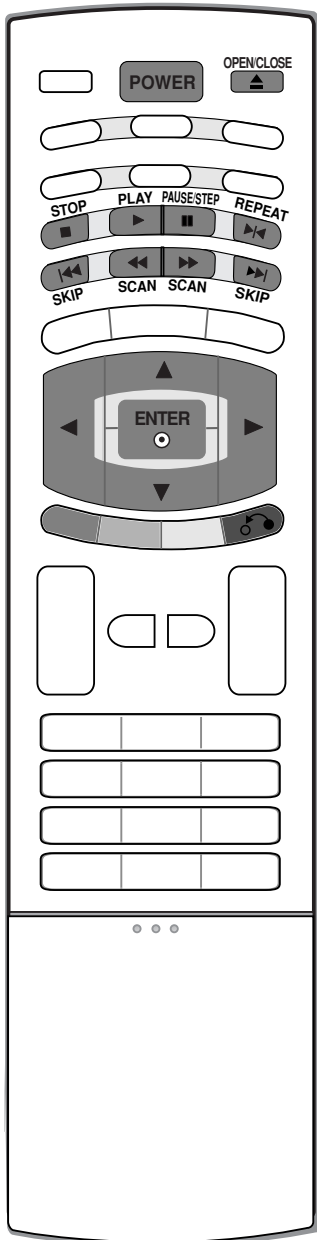

Basic Playback

DVD-V VCD DivX

- 1 Press the **POWER** button to turn the unit on.
- 2 Press **OPEN/CLOSE** button to open the disc tray and load your chosen disc in the tray, with the playback side down.
- 3 Press **OPEN/CLOSE** button to close the tray. Playback starts automatically. If playback does not start, press ► **PLAY** button.

Stop Playback

DVD-V VCD DivX

- 1 Press the ■ **STOP** button to stop playback. At this time the DVD video player stops playback temporarily and maintains the current playback position.
If you ► **PLAY** button is pressed, playback will resume from the location where you stopped playback.
- 2 Press the ■ **STOP** button again to stop playback fully.
At this time if you press ► **PLAY** button, the disc playback starts from the beginning.

Pause Playback (Still mode)

DVD-V VCD DivX

- 1 Press ■ **PAUSE/STEP** button during playback.
- 2 Press the ► **PLAY** button again to return to normal playback.

Still Picture and Frame-by-Frame Playback

DVD-V VCD DivX

- 1 Press ■ **PAUSE/STEP** button on the remote control during playback. Advance the picture frame-by-frame by pressing ■ **PAUSE/STEP** button repeatedly.
- 2 To exit still motion mode, press ► **PLAY** button.

Fast Forward/Backward

DVD-V VCD DivX

- 1 Press ◀◀ **SCAN** or ▶▶ **SCAN** button during playback.
- 2 Press ◀◀ **SCAN** or ▶▶ **SCAN** button repeatedly to select the required speed.
 - **DVD, DivX disc:** X2, X4, X16 or X100
 - **Video CD:** X2, X4 or X8
- 3 Press the ► **PLAY** button again to return to normal playback.

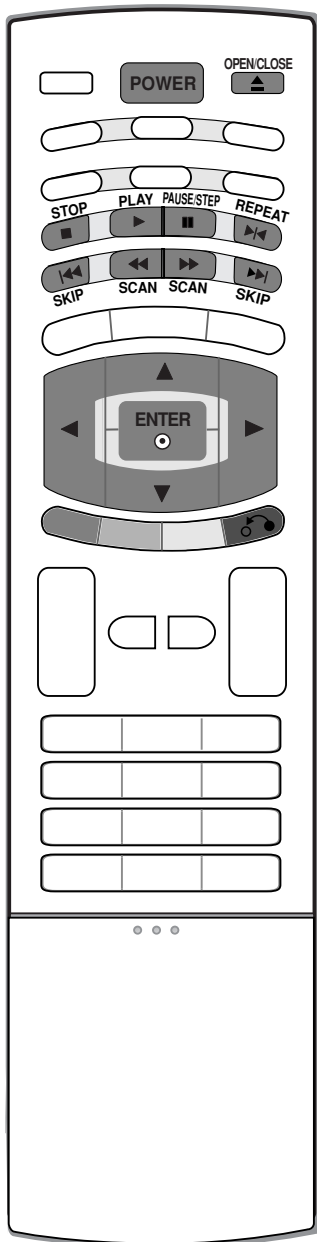

Slow Motion DVD-V VCD DivX

- 1 Press **II PAUSE/STEP** button on the remote control during playback. The DVD player will now go into PAUSE mode.
- 2 Use the **◀◀ SCAN** or **▶▶ SCAN** button to select the required speed: **◀◀ 1/16**, **◀◀ 1/8**, **◀◀ 1/4**, or **◀◀ 1/2** (backward), or **▶▶ 1/16**, **▶▶ 1/8**, **▶▶ 1/4**, or **▶▶ 1/2** (forward). With a DivX Disc and Video CD, the Slow speed changes: **▶▶ 1/16**, **▶▶ 1/8**, **▶▶ 1/4** or **▶▶ 1/2** (forward).
- 3 To exit Slow Motion mode, press **▶ PLAY** button.

Note

- a. There is no sound during fast or slow playback for DVDs or Video CDs.
- b. Slow motion playback in reverse is not possible with Video CDs and DivX Discs.

Moving to another CHAPTER/TRACK DVD-V VCD DivX

- 1 When a title on a disc has more than one chapter or a disc has more than one track, you can move to another chapter/track as follows:
 - Press **I◀◀ SKIP** or **▶▶I SKIP** button briefly during playback to select the next chapter/track or to return to the beginning of the current chapter/track.
 - Press **I◀◀ SKIP** button twice briefly to step back to the previous chapter/track.
 - To go directly to any chapter during DVD playback, press **DISPLAY** button and press **▲ / ▼** to select the chapter/track icon. Then, input the chapter/track number or use **◀ / ▶**.

Repeat Playback DVD-V VCD DivX

- You can play a specific title, chapter or track repeatedly.

- 1 Press the **▶◀ REPEAT** button during playback. Each time you press the **▶◀ REPEAT** button, the repeat mode changes as follows.
 - DVD Video Discs : **↻ Chapter** → **↻ Title** → **↻ Off**
 - Video CDs, DivX discs : **↻ Track** → **↻ All** → **↻ Off**

Note

- a. On a Video CD with PBC, you must set **PBC** to **Off** on the DVD menu to use the repeat function.
- b. If you press **▶▶I SKIP** button once during Repeat Chapter (Track) playback, the repeat playback cancels.

DVD operation

Playing a DVD or Video CD

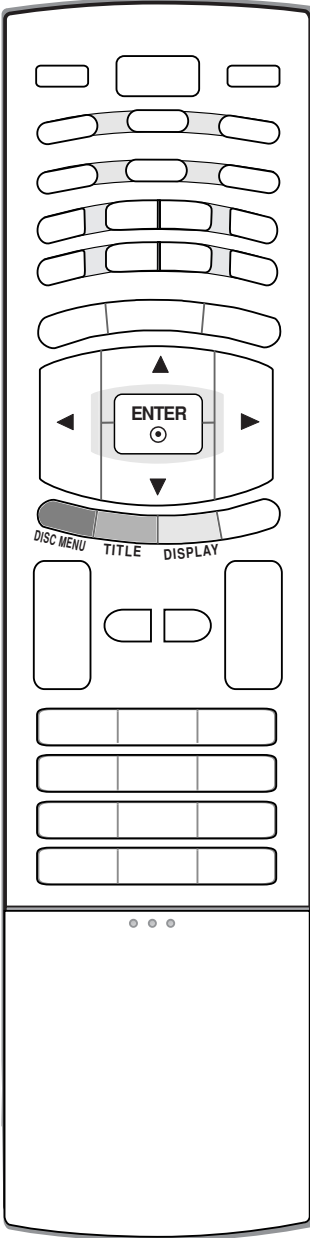

Disc Menu

DVD-V

- 1 Press the **DISC MENU** button during playback.
- 2 Use the **▲ / ▼ / ◀ / ▶** button or **ENTER** button to select the desired menu option.

Title Menu

DVD-V

- 1 Press the **TITLE** button during playback.
- 2 Use the **▲ / ▼ / ◀ / ▶** button or **ENTER** button to select the desired item.



Note

- a. The unit may not be able to select the disc or title menu depending on a sort of DVD disc.

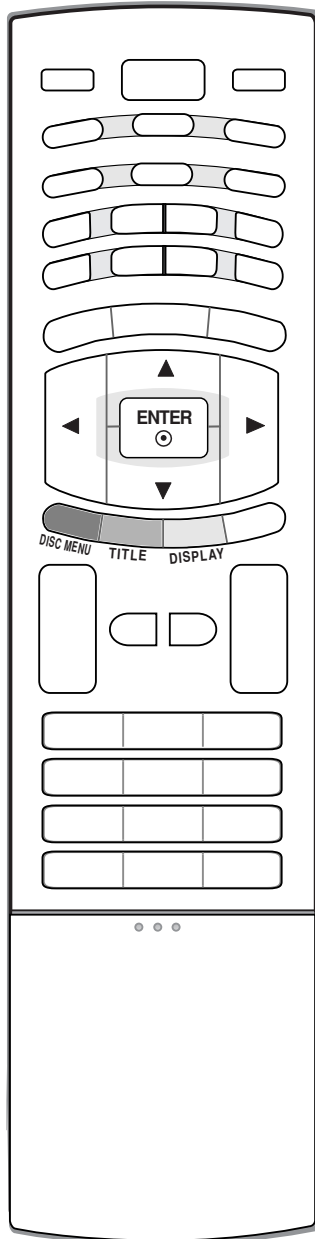

On-Screen Display

- 1** Press **DISPLAY** button during playback.
- 2** Use **▲ / ▼** button to select an item.
- 3** Press **◀ / ▶** button to change the setting. You can also use the number buttons if appropriate (e.g. inputting the title number). For some functions, press **ENTER** to execute the setting. Some discs may not provide all of the features shown below.

DVD-V	Items	Selection Method
• Title Number	◀ 1 / 3 ▶	• ◀ / ▶, Numbers → ENTER
• Chapter Number	1 / 12	• ◀ / ▶, Numbers → ENTER
• Time search	0:20:09	• Numbers → ENTER
• Audio language and Digital Audio Output mode	1 ENG □□□ 3/2.1CH	• ◀ / ▶ or AUDIO
• Subtitle language	1 ENG	• ◀ / ▶ or SUB_T
• Angle	1 / 3	• ◀ / ▶ or ANGLE
• Sound	3D SUR	• ◀ / ▶

VCD	Items	Selection Method
• Track Number (or PBC mode)	◀ 1 / 3 ▶	• ◀ / ▶, Numbers → ENTER
• Time search	0:20:09	• Numbers → ENTER
• Audio Channel	Stereo	• ◀ / ▶ or AUDIO
• Sound	3D SUR	• ◀ / ▶

DivX	Items	Selection Method
• Track Number	◀ 1 / 3 ▶	• ◀ / ▶, Numbers → ENTER
• Time search	0:20:09	• Numbers → ENTER
• Audio language and Digital Audio Output mode	1 MP3 2/0 CH	• ◀ / ▶ or AUDIO
• Subtitle language	1 ENG	• ◀ / ▶ or SUB_T
• Sound	3D SUR	• ◀ / ▶

DVD operation

Playing a DVD or Video CD

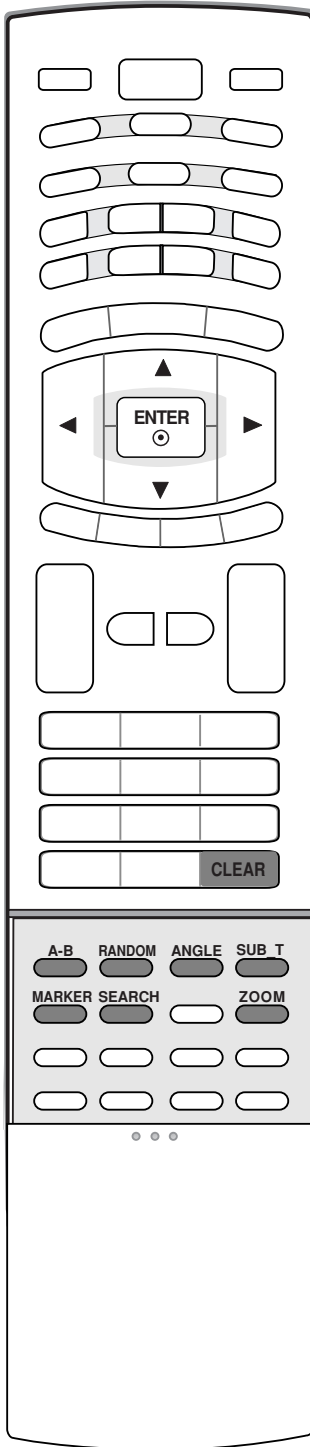

A-B Repeat Playback

DVD-V VCD DivX

- **A-B** repeat playback allows you to repeat material between two selected points.
- 1** Press the **A-B** button to select the start point during playback. “↻ **A***” is displayed on the TV screen and the starting point of your selected segment is set up.
- 2** Press the **A-B** button again to select the end point. “↻ **AB**” is displayed on the TV screen and the ending point is set up. Playback starts at the point that you selected. Playback stops at the end point, returns to Point **A** automatically, then starts again.
- 3** Repeatedly press the **A-B** button again to resume normal playback. “off” appears on the screen.

Random Playback

VCD

- 1** Press **RANDOM** button during playback. The unit automatically begins random playback and **RANDOM** appears on the TV screen.
- 2** Press **RANDOM** button again to normal.
- By pressing **▶▶ SKIP** button during random playback, the unit selects another title (track) and resumes random playback.



Note

- a. On a Video CD with PBC, You must set PBC to Off on the DVD menu to use the random function

Camera Angle

DVD-V

- If the scene was recorded from multiple angles, you can easily change the camera angle of the scene you are currently watching.
- 1** Press the **ANGLE** button during playback.
- 2** Repeatedly press the **ANGLE** button to select the desired angle.



Note

- a. You can only change the angle for DVDs that provide multiple angles of scenes.
- b. The angle function will not work on DVD video discs that do not contain scenes recorded at different angles.
- c. The number of angles varies from disc to disc.

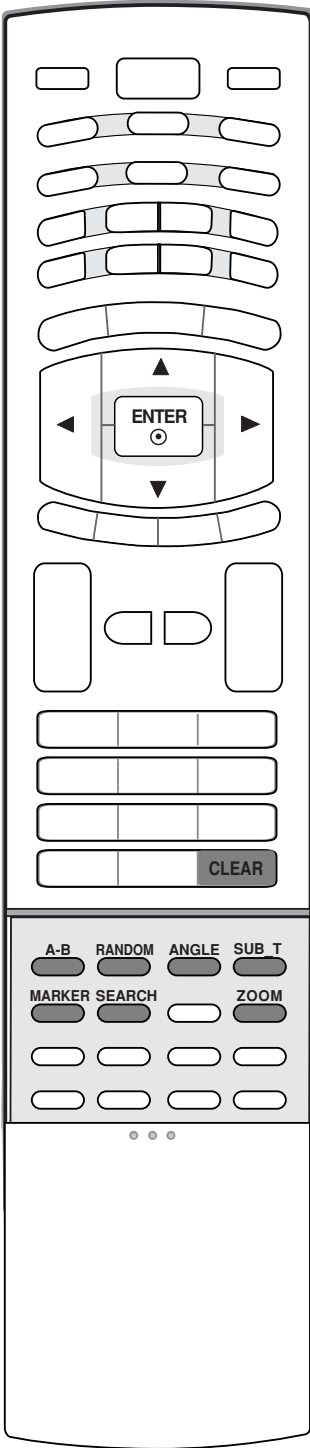

Subtitles

DVD-V DivX

- 1 Press **SUB_T** button repeatedly during playback to see the different subtitle languages.
If a subtitle language is selected, the selected subtitle language is played whenever you start a new disc playback. (The disc must contain the selected language)



Note

- a. The subtitle file of the DivX file is displayed only smi, srt and sub.
- b. If there is no information or there is a code that can not read in the DivX file, " 1 " etc are displayed.

Marker Search

DVD-V VCD DivX

- You can start playback from up to nine memorized points.

■ To enter a Marker 1 / 9

Press **MARKER** button during playback at the desired point on the disc. The **MARKER** icon appears on the TV screen briefly. Repeat to enter up to nine markers.

■ To Recall or Clear a Marked Scene

1. During disc playback, press **SEARCH** button. The **MARKER SEARCH** menu appears on the screen.
2. Within 10 seconds, press ◀ / ▶ button to select a marker number that you want to recall or clear.
3. Press **ENTER** button and playback starts from the marked scene. Or, Press **CLEAR** button and the marker number is erased from the list.
4. You can play any marker by inputting its number on the **MARKER SEARCH** menu.

Zoom

DVD-V VCD DivX

- Use zoom to enlarge the video image.

- 1 Press **ZOOM** button during playback or still playback. The square frame appears briefly in the right bottom of the picture.
- 2 Each press of the **ZOOM** button changes the TV screen in the sequence:
100% → 400% → 1600% → Screen fit mode → 100%
 - **Screen fit mode :**
You can change the way the image appears on the screen when you're playing a DVD movie. Press ▲ / ▼ button to select between Normal, Enhanced, and Maximum.
- 3 Use the ▲ / ▼ / ◀ / ▶ button to move through the zoomed picture.
- 4 To resume normal playback, press **CLEAR** button.



Note

- a. Zoom may not work on some DVDs.
- b. Screen fit mode is available for playing the DVD disc, VR disc and movie file.

DVD operation

Playing an Audio CD or MP3/WMA Disc

- The DVD player can play MP3/WMA formatted recordings on CD-ROM, CD-R, or CD-RW discs.

■ Audio CD

CD

1. Once you insert an audio CD a menu appears on the TV screen.
2. Press ▲ / ▼ button to select a track then press ► **PLAY** or **ENTER** button. Playback starts.

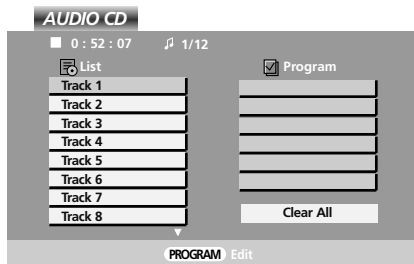

■ MP3 / WMA

MP3

WMA

1. Press ▲ / ▼ button to select a folder, and press **ENTER** button to see the folder contents.
2. Press ▲ / ▼ button to select a track then press ► **PLAY** or **ENTER** button. Playback starts.

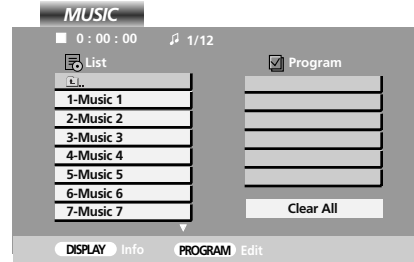

■ ID3 TAG

- When playing a file containing information such as track titles, you can see the information by pressing **DISPLAY** button. [Title, Artist, Album, Year, Comment]
- If there is no information, **NO ID3 TAG** appear on the display.

Pause Playback (Still mode)

CD

MP3

WMA

- 1 Press **II PAUSE/STEP** button during playback.
- 2 To return to playback, press ► **PLAY**, **ENTER** or press **II PAUSE/STEP** button again.

Fast Forward/Backward

CD

MP3

WMA

- 1 Press **◀◀ SCAN** or **▶▶ SCAN** button during playback.
- 2 Press **◀◀ SCAN** or **▶▶ SCAN** button repeatedly to select the required speed.
 - X2, X4 or X8
- 3 Press the ► **PLAY** button again to return to normal playback.

Moving to another Track

CD

MP3

WMA

- 1 Press **I◀◀ SKIP** or **▶▶I SKIP** button briefly during playback to go to the next track or to return to the beginning of the current track.
- 2 Press **I◀◀ SKIP** button twice briefly to go back to the previous track.
- 3 You can play any track by inputting its number.

Repeat Playback

CD

MP3

WMA

- You can play a track/all on a disc.

- 1 Press the **▶◀ REPEAT** button during playback.
- 2 Each time you press the **▶◀ REPEAT** button, the repeat mode changes as follows.
↻ **Track** → ↻ **All** → (Off)
 - If you press **▶▶ SKIP** button once during repeat track playback, the repeat playback cancels.

A-B Repeat Playback

CD

- **A-B** repeat playback allows you to repeat material between two selected points.

- 1 Press the **A-B** button to select the start point during playback. “↻ **A**” is displayed on the TV screen and the starting point of your selected segment is set up.
- 2 Press the **A-B** button again to select the end point. “↻ **A B**” is displayed on the TV screen and the ending point is set up. Playback starts at the point that you selected. Playback stops at the end point, returns to Point **A** automatically, then starts again.
- 3 To exit the sequence and return to normal play, press **A-B** button again. The Repeat icon disappears from the menu screen.

Random Playback

CD

MP3

WMA

- 1 Press **RANDOM** button during playback. The unit automatically begins random playback and **RANDOM** button appears on the TV screen.
- 2 Press **RANDOM** button again to normal.
 - By pressing **▶▶ SKIP** button during random playback, the unit selects another track and resumes random playback.

3D Surround

CD

To produce a 3D surround effect that simulates multi-channel audio from two stereo speakers (instead of the five+ speakers normally required for multi-channel audio from a home theater system).

- 1 Press **AUDIO** button during playback. “**3D SUR.**” appears on the menu screen.
- 2 To return to normal playback, press **AUDIO** button repeatedly until “**3D SUR.**” disappears from the menu screen.

■ MP3 / WMA disc compatibility with this player is limited as follows:

- Sampling frequency: within 8 - 48 kHz (MP3), within 32 - 48kHz (WMA)
- Bit rate: within 8 - 320kbps (MP3), 32 - 192kbps (WMA)
- The player cannot read an MP3/WMA file that has a file extension other than “.mp3” / “.wma”.
- CD-R physical format should be ISO 9660 or JOLIET file.
- If you record MP3 / WMA files using software that cannot create a file system (eg. Direct-CD) it is impossible to playback MP3 / WMA files. We recommend that you use Easy-CD Creator, which creates an ISO 9660 file system.
- File names should have a maximum of 8 letters and must incorporate an .mp3 or .wma extension.
- They should not contain special letters such as / ? * : “ < > | etc.
- The total number of files on the disc should be less than 650.
- Play a MP3 file that made by user for personal purpose. Use other MP3 Player if an MP3 file is protected by copyright.

DVD operation

Programmed Playback

- The program function enables you to store your favorite tracks from any disc in the player memory. A program can contain 30 tracks.

- 1 Insert a disc.
- 2 Press **PROGRAM** button.
The **E** mark will appear to the right of the word **Program** on the right side of the menu screen.
 - Press **PROGRAM** button again, then the **E** mark will disappear to exit the Program Edit mode.

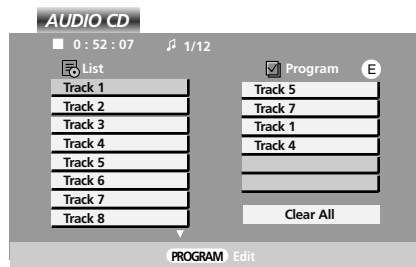

Audio CD Menu

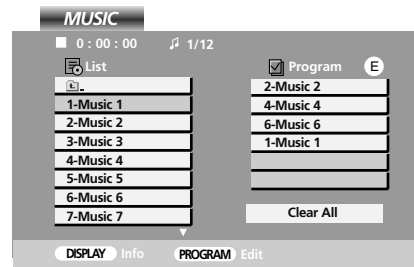

MP3/WMA Menu

- **Video CD:** Press **PROGRAM** button while playback is stopped. The program menu appears. Press **PROGRAM** button again and hold it down for a few seconds to exit the menu.



Note

- a. On a Video CD with **PBC**, you must set **PBC** to **Off** on the setup menu to use the programmed playback.

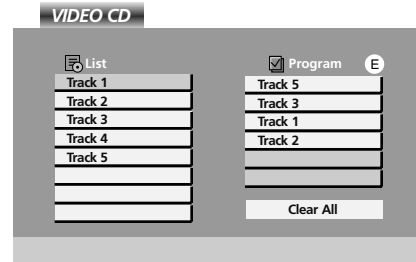

- 3 Select a track on the **List**, then press **ENTER** button to place the selected track on the **Program** list. Repeat to place additional tracks on the list.
- 4 Press **▶** button.
Select the track you want to start playing on the **Program** list.
- 5 Press **PLAY** or **ENTER** button to start.
Playback begins in the order in which you programmed the tracks. Playback stops after all of the tracks on the **Program** list have played once.
- 6 To resume normal playback from programmed playback, select a track on the **List** and then press **PLAY** button.

Repeat Programmed Tracks

1. Press the **REPEAT** button during playback.
2. Each time you press the **REPEAT** button, the repeat mode changes as follows.

Erasing a Track from Program list

1. Use **▲ / ▼ / ▶** button to select the track that you wish to erase from the Program list.
2. Press **CLEAR** button. Repeat to erase additional tracks on the list.

Erasing the Complete Program list

1. Press **▶** button to move to the **Program** list.
2. Use **▲ / ▼** button to select **Clear All**, then press **ENTER** button .



Note

- a. The programs are also cleared when the disc is removed.

Viewing a JPEG Disc

- Using this DVD Player you can view Kodak PICTURE CDs and discs with JPEG files.

- 1 Insert a disc and close the tray. The **PHOTO** menu appears on the TV screen.

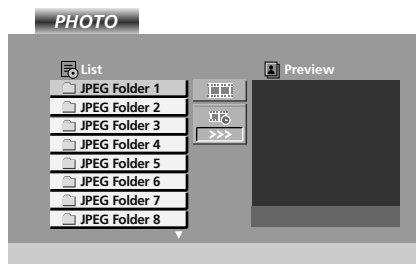

- 2 Press **▲ / ▼** button to select a folder, and press **ENTER** button. A list of files in the folder appears. If you are in a file list and want to return to the previous Folder list, use the **▲ / ▼** button on the remote to highlight  and press **ENTER** button.
 - Press **DISC MENU** button to move to the next page
 - On a disc with MP3/WMA and JPEG you can switch MP3/WMA and JPEG. Press **TITLE** button and MUSIC or PHOTO word on top of the menu is highlighted.
- 3 If you want to view a particular file, press **▲ / ▼** button to highlight a file and press **ENTER** or **▶ PLAY** button. Viewing the file proceeding starts.
 - While viewing a file, you can press **■ STOP** button to move to the previous **PHOTO** menu.
 - While viewing a file, If you press **RETURN** button, information of file is hidden.

■ Slide Show

1. Use **▲ / ▼ / ◀ / ▶** button to highlight the  (Slide Show) then press **ENTER** button.

■ Slide Speed

There are three slide speed options :

>>> (Fast) → **>>** (Normal) → **>** (Slow)

1. Use **▲ / ▼ / ◀ / ▶** button to highlight the Speed. Then, use **◀ / ▶** button to select the option you want to use then press **ENTER** button.

■ Still Picture

1. Press **II PAUSE/STEP** button during slide show. The player will now go into PAUSE mode.
2. To return to the slide show, press **▶ PLAY** or press **II PAUSE/STEP** button again.

■ Moving to another File

1. Press **I◀◀ SKIP** , **▶▶I SKIP** , **◀** or **▶** button once while viewing a picture to advance to the next or previous file.

■ Zoom

1. Press **ZOOM** button during playback or still playback. The square frame appears briefly in the right bottom of the picture.
2. Each press of the **ZOOM** button changes the TV screen in the sequence:
100% → 400% → 1600% → 100%
3. Use the **▲ / ▼ / ◀ / ▶** buttons to move through the zoomed picture.
4. To resume normal playback, press **CLEAR** button.

■ To rotate picture

1. Press **▲ / ▼** button during showing a picture to rotate the picture clockwise or counter clockwise.

DVD operation

Viewing a JPEG Disc

■ To listen to MP3/WMA music watching picture

You can display files while listening to MP3/WMA music files recorded on the same disc.

1. Insert the disc containing the two types of file in the player.
2. Press **TITLE** button to display **PHOTO** menu.
3. Press **▲** / **▼** button to select a photo file.
4. Use **▶** button to select  icon then press **ENTER** button.

Playback starts. The playback will continue until ■ **STOP** button is pressed.

- To listen to only the desired music watching picture, programmed the desired tracks from the **MUSIC** menu and then proceed as above.

■ JPEG disc compatibility with this player is limited as follows:

- Depending upon the size and number of JPEG files, it could take a long time for the DVD player to read the disc's contents. If you don't see an on-screen display after several minutes, some of the files may be too large — reduce the resolution of the JPEG files to less than 2M pixels as 2760 x 2048 pixels and burn another disc.
- The total number of files and folders on the disc should be less than 650.
- Some discs may be incompatible due to a different recording format or the condition of disc.
- Ensure that all the selected files have the ".jpg" extensions when copying into the CD layout.
- If the files have ".jpe" or ".jpeg" extensions, please rename them as ".jpg" file.
- File names without ".jpg" extension will not be able to be read by this DVD player. Even though the files are shown as JPEG image files in Windows Explorer.

Playing a DVD VR format Disc

- This unit will play DVD-R/RW discs recorded using the DVD-Video format that have been finalized using a DVD-recorder.
- This unit will play DVD-RW discs recorded using the Video Recording (VR) format.

- 1 Insert a disc and close the tray. The DVD-VR menu appears on the TV screen.

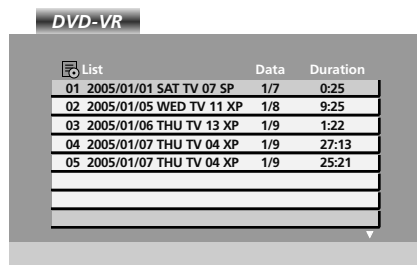

- 2 Press **▲** / **▼** button to select a track then press **▶** **PLAY** or **ENTER** button and playback starts.



Note

- a. Unfinalized DVD-R/RW discs cannot be played in this player.
- b. Some DVD-VR disc are made with CPRM data by DVD RECORDER. Player does not support these kinds of discs and display the **CHECK DISC**.

• What is 'CPRM'?

CPRM is a copy protection system (with scramble system) only allowing the recording of 'copy once' broadcast programs. CPRM stands for Content Protection for Recordable Media.

This player is CPRM compatible, which means that you can record copy-once broadcast programs, but you cannot then make a copy of those recordings. CPRM recordings can only be made on DVD-RW discs formatted in VR mode, and CPRM recordings can only be played on players that are specifically compatible with CPRM.

Playing a DivX Movie Disc

- Using this DVD Player you can play DivX (Digital Internet Video eXpress) disc.

1 Insert a disc and close the tray. The **MOVIE** menu appears on the TV screen.

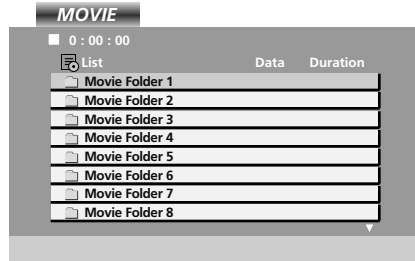

2 Press **▲** / **▼** button to select a folder, and press **ENTER** button. A list of files in the folder appears. If you are in a file list and want to return to the Folder list, use the **▲** / **▼** button on the remote to highlight **⏪**, and press **ENTER** button.

3 If you want to view a particular file, press **▲** / **▼** button to highlight a file and press **ENTER** or **▶ PLAY** button.

4 Press **■ STOP** button to exit.

- On a CD with MP3/WMA, JPEG and MOVIE file, you can switch **MUSIC**, **PHOTO** and **MOVIE** menu. Press **TITLE** button and **MUSIC**, **PHOTO** and **MOVIE** word on top of the menu is highlighted.

■ DivX disc compatibility with this player is limited as follows:

- Available resolution size of the DivX file is under 720x576 (W x H) pixel.
- The file name of the DivX subtitle is available by 56 characters.
- If there is impossible code to express in the DivX file, it may be displayed as " _ " mark on the display.
- If the number of the screen frame is over 30 per 1 second, this unit may not operate normally.
- If the video and audio structure of recorded file is not interleaved, either video or audio is outputted.
- If the file is recorded with **GMC**, the unit supports only 1-point of the record level.

What is 'GMC'?

GMC is the acronym for Global Motion Compensation. It is an encoding tool specified in MPEG4 standard. Some MPEG4 encoders, like DivX or Xvid, have this option. There are different levels of GMC encoding, usually called 1-point, 2-point, or 3-point GMC.

- Playable DivX file : ".avi ", ".mpg ", ".mpeg "
- Playable Codec format
"DIVX3.xx ", "DIVX4.xx ", "DIVX5.xx ", "XVID ", "MP43 ", "3IVX "
- Playable Audio format
"AC3 ", "DTS ", "PCM ", "MP3 ", "WMA "
 - Sampling frequency: within 8 - 48 kHz (MP3), within 32 - 48kHz (WMA)
 - Bit rate: within 8 - 320kbps (MP3), 32 - 192kbps (WMA)

Reference

Language Codes

Use this list to input your desired language for the following initial settings: **Disc Audio, Disc Subtitle, Disc Menu.**

Language	Code	Language	Code	Language	Code	Language	Code
Abkhazian	6566	Fiji	7074	Lingala	7678	Singhalese	8373
Afar	6565	Finnish	7073	Lithuanian	7684	Slovak	8375
Afrikaans	6570	French	7082	Macedonian	7775	Slovenian	8376
Albanian	8381	Frisian	7089	Malagasy	7771	Somali	8379
Ameharic	6577	Galician	7176	Malay	7783	Spanish	6983
Arabic	6582	Georgian	7565	Malayalam	7776	Sudanese	8385
Armenian	7289	German	6869	Maltese	7784	Swahili	8387
Assamese	6583	Greek	6976	Maori	7773	Swedish	8386
Aymara	6588	Greenlandic	7576	Marathi	7782	Tagalog	8476
Azerbaijani	6590	Guarani	7178	Moldavian	7779	Tajik	8471
Bashkir	6665	Gujarati	7185	Mongolian	7778	Tamil	8465
Basque	6985	Hausa	7265	Nauru	7865	Tatar	8484
Bengali; Bangla	6678	Hebrew	7387	Nepali	7869	Telugu	8469
Bhutani	6890	Hindi	7273	Norwegian	7879	Thai	8472
Bihari	6672	Hungarian	7285	Oriya	7982	Tibetan	6679
Breton	6682	Icelandic	7383	Panjabi	8065	Tigrinya	8473
Bulgarian	6671	Indonesian	7378	Pashto, Pushto	8083	Tonga	8479
Burmese	7789	Interlingua	7365	Persian	7065	Turkish	8482
Byelorussian	6669	Irish	7165	Polish	8076	Turkmen	8475
Cambodian	7577	Italian	7384	Portuguese	8084	Twi	8487
Catalan	6765	Japanese	7465	Quechua	8185	Ukrainian	8575
Chinese	9072	Javanese	7487	Rhaeto-Romance	8277	Urdu	8582
Corsican	6779	Kannada	7578	Rumanian	8279	Uzbek	8590
Croatian	7282	Kashmiri	7583	Russian	8285	Vietnamese	8673
Czech	6783	Kazakh	7575	Samoan	8377	Volapük	8679
Danish	6865	Kirghiz	7589	Sanskrit	8365	Welsh	6789
Dutch	7876	Korean	7579	Scots Gaelic	7168	Wolof	8779
English	6978	Kurdish	7585	Serbian	8382	Xhosa	8872
Esperanto	6979	Laothian	7679	Serbo-Croatian	8372	Yiddish	7473
Estonian	6984	Latin	7665	Shona	8378	Yoruba	8979
Faroese	7079	Latvian, Lettish	7686	Sindhi	8368	Zulu	9085

Area Codes

Choose a country code from this list.

Country	Code	Country	Code	Country	Code	Country	Code
Afghanistan	AF	Ethiopia	ET	Malaysia	MY	Saudi Arabia	SA
Argentina	AR	Fiji	FJ	Maldives	MV	Senegal	SN
Australia	AU	Finland	FI	Mexico	MX	Singapore	SG
Austria	AT	France	FR	Monaco	MC	Slovak Republic	SK
Belgium	BE	Germany	DE	Mongolia	MN	Slovenia	SI
Bhutan	BT	Great Britain	GB	Morocco	MA	South Africa	ZA
Bolivia	BO	Greece	GR	Nepal	NP	South Korea	KR
Brazil	BR	Greenland	GL	Netherlands	NL	Spain	ES
Cambodia	KH	Islands	HM	Netherlands Antilles	AN	Sri Lanka	LK
Canada	CA	Hong Kong	HK	New Zealand	NZ	Sweden	SE
Chile	CL	Hungary	HU	Nigeria	NG	Switzerland	CH
China	CN	India	IN	Norway	NO	Taiwan	TW
Colombia	CO	Indonesia	ID	Oman	OM	Thailand	TH
Congo	CG	Israel	IL	Pakistan	PK	Turkey	TR
Costa Rica	CR	Italy	IT	Panama	PA	Uganda	UG
Croatia	HR	Jamaica	JM	Paraguay	PY	Ukraine	UA
Czech Republic	CZ	Japan	JP	Philippines	PH	United States	US
Denmark	DK	Kenya	KE	Poland	PL	Uruguay	UY
Ecuador	EC	Kuwait	KW	Portugal	PT	Uzbekistan	UZ
Egypt	EG	Libya	LY	Romania	RO	Vietnam	VN
El Salvador	SV	Luxembourg	LU	Russian Federation	RU	Zimbabwe	ZW

Reference

Troubleshooting Checklist

The operation does not work normally.	
The remote control doesn't work	<ul style="list-style-type: none"> • Check to see if there is any object between the product and the remote control causing obstruction. • Are batteries installed with correct polarity (+ to +, - to -)? • Correct remote operating mode set: TV, VCR etc.? • Install new batteries.
Power is suddenly turned off	<ul style="list-style-type: none"> • Is the sleep timer set? • Check the power control settings. Power interrupted • No broadcast on station tuned with Auto off activated.

The video function does not work.	
No picture & No sound	<ul style="list-style-type: none"> • Check whether the product is turned on. • Try another channel. The problem may be with the broadcast. • Is the power cord inserted into wall power outlet? • Check your antenna direction and/or location. • Test the wall power outlet, plug another product's power cord into the outlet where the product's power cord was plugged in.
Picture appears slowly after switching on	<ul style="list-style-type: none"> • This is normal, the image is muted during the product startup process. Please contact your service center, if the picture has not appeared after five minutes.
No or poor color or poor picture	<ul style="list-style-type: none"> • Adjust Color in menu option. • Keep a sufficient distance between the product and the VCR. • Try another channel. The problem may be with the broadcast. • Are the video cables installed properly? • Activate any function to restore the brightness of the picture.
Horizontal/vertical bars or picture shaking	<ul style="list-style-type: none"> • Check for local interference such as an electrical appliance or power tool.
Poor reception on some channels	<ul style="list-style-type: none"> • Station or cable product experiencing problems, tune to another station. • Station signal is weak, reorient antenna to receive weaker station. • Check for sources of possible interference.
Lines or streaks in pictures	<ul style="list-style-type: none"> • Check antenna (Change the direction of the antenna).

Reference

Troubleshooting Checklist

The audio function does not work.	
Picture OK & No sound	<ul style="list-style-type: none"> • Press the VOL (or Volume) button. • Sound muted? Press MUTE button. • Try another channel. The problem may be with the broadcast. • Are the audio cables installed properly?
No output from one of the speakers	<ul style="list-style-type: none"> • Adjust Balance in menu option.
Unusual sound from inside the product	<ul style="list-style-type: none"> • A change in ambient humidity or temperature may result in an unusual noise when the product is turned on or off and does not indicate a fault with the product.

There is a problem in PC mode. (Only PC mode applied)	
The signal is out of range.	<ul style="list-style-type: none"> • Adjust resolution, horizontal frequency, or vertical frequency. • Check it whether the signal cable is connected or loose. • Check the input source.
Vertical bar or stripe on background & Horizontal Noise & Incorrect position	<ul style="list-style-type: none"> • Work the Auto configure or adjust clock, phase, or H/V position.
Screen color is unstable or single color	<ul style="list-style-type: none"> • Check the signal cable. • Reinstall the PC video card.

Reference

Maintenance

- Early malfunctions can be prevented. Careful and regular cleaning can extend the amount of time you will have your new TV. Be sure to turn the power off and unplug the power cord before you begin any cleaning.

Cleaning the Screen

1. Here's a great way to keep the dust off your screen for a while. Wet a soft cloth in a mixture of luke-warm water and a little fabric softener or dish washing detergent. Wring the cloth until it's almost dry, and then use it to wipe the screen.
2. Make sure the excess water is off the screen, and then let it air-dry before you turn on your TV.

Cleaning the Cabinet

To remove dirt or dust, wipe the cabinet with a soft, dry, lint-free cloth. Please be sure not to use a wet cloth.

Extended Absence



If you leave your TV dormant for a long time (such as a vacation), it's a good idea to unplug the power cord to protect against possible damage from lightning or power surges.

Product Specifications

Power Requirement	AC 100-240V~ 50/60Hz 1.4A
Power Consumption	120W
Television System	NTSC
Television Channel	VHF : 2 ~ 13, UHF : 14 ~ 69, Cable : 1 ~ 125
Television Screen	LCD Panel
External Antenna Impedance	75 Ω
Audio Output	7 W + 7 W

Memo

Memo

